



rf/microwave instrumentation

Operating and Service Manual

10000W1000A

Model

10042514

Part Number

Serial Number



rf/microwave instrumentation

Declaration of Conformity

Issue Date: April 2016
Model #/s: 10000W1000A series
Type of Equipment: RF broadband amplifier
Function: Designed to be used in a RF immunity test system or for research. The unit is intended to amplify an RF signal and inject it into a load.

The equipment described above is declared to be in conformity with the following applicable national and international standards. The conformity is valid only when equipment is used in a manner consistent with the manufacturer's recommendations and the reference documents.

EMC:

DIRECTIVE 2014/30/EU OF THE EUROPEAN PARLIAMENT AND OF THE COUNCIL of 26 February 2014 on the harmonisation of the laws of the Member States relating to electromagnetic compatibility

EN 61326-1:2013 Electrical equipment for measurement, control and laboratory use—EMC requirements—Part 1: General Requirements

SAFETY:

- **DIRECTIVE 2014/35/EU OF THE EUROPEAN PARLIAMENT AND OF THE COUNCIL** of 26 February 2014 on the harmonisation of the laws of the Member States relating to the making available on the market of electrical equipment designed for use within certain voltage limits

CENELEC EN 61010-1 Issued 2010/10/01 Ed: 3

Safety Requirements for Electrical Equipment for Measurement Control and Laboratory Use – Part 1: General Requirements

- **UL 61010-1 Issued 2012/05/11 Ed: 3**
Safety Requirements for Electrical Equipment for Measurement Control and Laboratory Use – Part 1: General Requirements
- **CAN/CSA C22.2 #61010-1 Issued 2012/05/11 Ed: 3**
Safety Requirements for Electrical Equipment for Measurement Control and Laboratory Use – Part 1: General Requirements

HAZARDOUS SUBSTANCES (RoHS):

DIRECTIVE 2011/65/EU OF THE EUROPEAN PARLIAMENT AND OF THE COUNCIL of 8 June 2011 on the restriction of the use of certain hazardous substances in electrical and electronic equipment (recast)

RECYCLING (WEEE):

DIRECTIVE 2012/19/EU OF THE EUROPEAN PARLIAMENT AND OF THE COUNCIL of 4 July 2012 on waste electrical and electronic equipment (WEEE) (recast)

Supporting documentation is held by AR RF/Microwave Instrumentation's quality department in Pennsylvania, United States.

Place of issue: AR RF/Microwave Instrumentation
160 School House Road
Souderton, Pennsylvania 18964 USA

Authorized officer of the company:

James M. Maginn
President

Instructions for European EMC Conformity



It is the responsibility of the user of this equipment to provide electromagnetic shielding, filtering and isolation which is necessary for EMC compliance to Directive 2014/30/EU. The equipment must therefore be operated in a shielded area which provides a sufficient level of attenuation to meet the radiated emissions and immunity specifications. The following minimum levels are suggested for use in accordance with the rated power of the equipment.

Rated Power	Minimum shielding attenuation
100 watts	50 dB
101 - 1000 watts	60 dB
1001 - 10,000 watts	70 dB

Since this equipment is designed to generate high levels of Radio Frequency energy, it is also essential that the user read and follow the “Instructions for Safe Operation” in this manual. If other equipment is operated in the shielded room it may be disturbed by the amplifier.



Der Benutzer dieses Gerätes ist dafür verantwortlich, daß die elektromagnetische Abschirmung und Filterung gewährleistet ist, welche gemäß Richtlinie 2014/30/EU notwendig ist. Das Gerät muß deshalb in einem geschirmten Raum betrieben werden, welcher eine ausreichenden Schirmung bietet, um die Emissions- und Störfestigkeitsspezifikation einzuhalten. Es werden folgenden Minimalwerte der Schirmdämpfung und Filterung in den unterschiedlichen Leistungsklassen empfohlen.

Hochfrequenzleistung	min. Schirmdämpfung
100 Watt	50 dB
101-1000 Watt	60 dB
1001-10.000 Watt	70 dB

Falls andere elektrische oder elektronische Geräte gleichzeitig mit dem Gerät betrieben werden, kann es zu Beeinflussungen kommen. Da das Gerät zur Erzeugung von Hochfrequenzenergie dient ist es daher auch unbedingt notwendig, daß der Benutzer die Sicherheitsvorschriften in der Bedienungsanleitung liest und einhält.



Il est de la responsabilité de l'utilisateur de cet équipement d'assurer la protection électromagnétique, le filtrage et l'isolation nécessaires, afin de se conformer à la directive 2014/30/EU concernant la C.E.M. Par conséquent, cet équipement doit être mis en fonctionnement dans une enceinte d'atténuation suffisante pour satisfaire aux spécifications d'émissivité et de susceptibilité. Pour une utilisation conforme, les niveaux d'atténuation minimums suivants sont suggérés en fonction de la puissance de sortie de l'équipement:

Puissance de sortie	Atténuation minimum de l'enceinte
100 Watts	50 dB
101 à 1.000 Watts	60 dB
1.001 à 10.000 Watts	70 dB

Puisque cet équipement est destiné à générer de forts niveaux R.F., il est essentiel que l'utilisateur se conforme aux instructions de sécurité indiquées dans ce manuel. Tout autre équipement en fonctionnement dans la cage de Faraday peut-être perturbé par l'amplificateur.

INSTRUCTIONS FOR SAFE OPERATION









Observe the following safety guidelines to help ensure your own personal safety and to help protect your equipment and working environment from potential damage.

INTENDED USE

This equipment is intended for general laboratory use in generating, controlling, and measuring levels of electromagnetic Radio Frequency (RF) energy. Ensure that the device is operated in a location which will control the radiated energy and will not cause injury or violate regulatory levels of electromagnetic interference.

SAFETY SYMBOLS

These symbols may appear in your user manual or on equipment.

	This symbol is marked on the equipment when it is necessary for the user to refer to the manual for important safety information. The caution symbol denotes a potential hazard. Attention must be given to the statement to prevent damage, destruction, or harm.
	Dangerous voltages are present. Use extreme care.
	Indicates a terminal intended for connection to an external conductor for protection against electrical shock in case of a fault, or the terminal of a protective earth (ground) electrode.
	Indicates invisible laser radiation—do not view directly with optical instruments.
	Indicates frame or chassis ground connection terminal.
	Indicates alternating current.
	Indicates this product must not be disposed of with your other household waste.
	Indicates that the marked surface and adjacent surfaces can attain temperatures that may be hot to the touch.

EQUIPMENT SETUP PRECAUTIONS

 Review the user manual and become familiar with all safety markings and instructions. Protection provided by the equipment may be impaired if used in a manner not specified by AR RF/Microwave Instrumentation (AR).

- Follow all lifting instructions specified in this document.
- Place the equipment on a hard, level surface.
- Do not use the equipment in a wet environment, for example, near a sink, or in a wet basement.

- Position your equipment so that the power switch is easily accessible.
- Leave 10.2 cm (4 in) minimum of clearance on all vented sides of the equipment to permit the airflow required for proper ventilation. Do not restrict airflow into the equipment by blocking any vents or air intakes. Restricting airflow can result in damage to the equipment, intermittent shut-downs or safety hazards.
- Keep equipment away from extremely hot or cold temperatures to ensure that it is used within the specified operating range.
- While installing accessories such as antennas, directional couplers and field probes, take care to avoid any exposure to hazardous RF levels.
- Ensure that nothing rests on your equipment's cables and that the cables are not located where they can be stepped on or tripped over.
- Move equipment with care; ensure that all casters and/or cables are firmly connected to the system. Avoid sudden stops and uneven surfaces.

BEFORE APPLYING POWER

Your AR equipment may have more than one power supply cable. Use only approved power cable(s). If you have not been provided with a power cable for the equipment or for any AC-powered option intended for the equipment, purchase a power cable that is approved for use in your country. The power cable must be rated for the equipment and for the voltage and current marked on the equipment's electrical ratings label.



Incorrectly installing or using an incompatible line voltage may increase the risk of fire or other hazards. To help prevent electric shock, plug the equipment and peripheral power cables into properly grounded electrical outlets. These cables are equipped with three-prong plugs to help ensure proper grounding. Do not use adapter plugs or remove the grounding prong from a cable.

Do not modify power cables or plugs. Consult a licensed electrician or AR trained service technician for equipment modifications. Always follow your local/national wiring rules.



Do not operate the equipment if there is physical damage, missing hardware, or missing panels.

SAFETY GROUND



This equipment is provided with a protective earth terminal. The mains power source to the equipment must supply an uninterrupted safety ground of sufficient size to attach wiring terminals, power cord, or supplied power cord set. ***DO NOT USE this equipment if this protection is impaired.***

INSTRUCTIONS FOR SAFE OPERATION

HAZARDOUS RF VOLTAGES



The RF voltages on the center pin of an RF output connector can be hazardous. The RF output connector should be connected to a load before AC power is applied to the equipment. Do not come into contact with the center pin of the RF output connector or accessories connected to it. Place the equipment in a non-operating condition before disconnecting or connecting the load to the RF output connector.

ACOUSTIC LIMITATIONS

If equipment noise exceeds 80dB, ear protection is required.

MAINTENANCE CAUTION

Adjustment, maintenance, or repair of the equipment must be performed only by qualified personnel. Hazardous energy may be present while protective covers are removed from the equipment even if disconnected from the power source. Contact may result in personal injury. Replacement fuses are required to be of specific type and current rating.

ENVIRONMENTAL CONDITIONS

Unless otherwise stated on the product specification sheet, this equipment is designed to be safe under the following environmental conditions:

- Indoor use
- Altitude up to 2000m
- Temperature of 5°C to 40°C
- Maximum relative humidity 80% for temperatures up to 31°C. Decreasing linearly to 50% at 40°C.
- Main supply voltage fluctuations not to exceed $\pm 10\%$ of the nominal voltage or minimum and maximum autoranging values.
- Pollution degree 2: Normally non-conductive with occasional condensation. While the equipment will not cause hazardous condition over this environmental range, its performance may vary.

EQUIPMENT CONTAINING LASERS



AR Field Probes (FL/PL Series) and Field Analyzers (FA Series) are Class 1 laser products containing embedded Class 4 lasers. Under normal use, the laser radiation is completely contained within the fiber optic cables and poses no threat of exposure. Safety interlocks ensure that the laser is not activated unless the cables are properly connected. Always exercise caution when using or maintaining laser products. Do not view directly with optical instruments.

RF ANTENNAS

- This equipment (antenna or antenna assembly) may be heavy, requiring two persons to lift. Use caution when installing or removing unit. Follow all equipment setup and lifting instructions specified in this document.
- Ensure connectors are appropriate for intended operation. Connectors are specified in the user manual and product specification sheet.
- Do not exceed the maximum RF input level stated in the specifications. Refer to the user manual and product specification sheet to determine the applicable RF levels.
- Excessive RF input could damage the equipment or connectors, causing safety hazards.
- When in operation, the RF voltages on the antenna elements can be hazardous. Do not come into contact with the antenna or elements when the RF input connector is connected to a live RF source.
- To avoid injury to personnel and accidental damage to power amplifier or antenna, disable the RF output of power amplifier before connecting or disconnecting the input connection to the antenna.
- Perform periodic inspections of antenna and field probe systems to verify calibration due date, proper operation, and overall condition of equipment.

RACK MOUNTED TWT MODELS

Some TWT models are supplied without the removable enclosure offered for benchtop use. These rack-mountable models may be supplied with either carry handles or slides and front handles installed. Follow all lifting instructions specified in this document and installation instructions supplied in the TWT user manual.

LIFTING INSTRUCTIONS FOR AR EQUIPMENT

Because most products must be handled during distribution, assembly and use, the risk of serious injury due to unsafe product handling should be a fundamental consideration of every user. An authoritative guideline for eliminating unwarranted risk of injury caused by lifting is provided by the NIOSH Work Practices (Publication #94-110) available at:



<https://www.cdc.gov/niosh/docs/94-110/pdfs/94-110.pdf>.

In general, observe the following guidelines for lifting a weight of 50 lb or more:

- Use lifting eye (for floor standing) or side handles (table top) to lift unit only.
- Use equipment of adequate capacity to lift and support unit.
- If using forklift to move unit, be sure forks are long enough to extend beyond the side of the unit.

For additional information, follow the link specified above.

Contents

1.	GENERAL INFORMATION	1
1.1	General Description	1
1.2	Specifications.....	1
1.3	Power Supplies	2
1.4	Protection Circuits	2
1.5	Installation	3
1.5.1	Location	3
1.5.2	AC Power.....	3
1.5.3	Main Power.....	4
1.5.4	Model 10000W1000A Controller Interconnections	4
1.6	Other Connectors	7
1.6.1	RF Input Connector	7
1.6.2	RF Sample Ports	7
1.6.3	RF Output Connector.....	7
1.6.3.1	10kW Output.....	7
1.6.4	Safety Interlock Connector	7
1.6.5	Communications Connectors	7
1.6.5.1	RS232 Wire.....	7
1.6.5.2	RS232 Fiber-optic	7
1.6.5.3	IEEE-488.....	8
1.6.5.4	USB.....	8
1.6.5.5	Ethernet	8
2.	OPERATING INSTRUCTIONS.....	9
2.1	General.....	9
2.2	System Overview	9
2.3	Interface Identification and Diagrams	10
2.4	RF Input.....	10
2.5	Operator Command and Control Interface	10
2.5.1	Local Control Interface	11
2.5.1.1.	Keylock Switch	11
2.5.1.2	Power Button.....	12
2.5.1.3	Adjust Knob	12
2.5.1.4	Touch Screen.....	12
2.5.1.5	Menu Map	13
2.5.2	Remote Control Interface.....	20
2.5.2.1	GPIB (IEEE-488) Communication	20
2.5.2.2	RS-232 Communication.....	20
2.5.2.3	Fiber-Optic Serial Communication	21
2.5.2.4	USB Communication	22
2.5.2.5	Ethernet Communication.....	22
2.5.2.6	Remote Commands	23
2.5.2.7	Interlocks.....	36
2.6	RF Output	37
2.7	Electrical Power.....	37
3.	THEORY OF OPERATION	39
3.1	Introduction.....	39
3.2	RF Amplifier Operation (Driver/Controller Amplifier, Schematic 10044325) ...	39

3.2.1	A1 Variable Gain Amplifier (Block Diagram 10034229).....	39
3.2.1.1	A1 Pre-Amplifier PWB Assembly (Schematic 10033908)	39
3.2.1.2	A2 High Isolation Switch (Schematic 10031969)	39
3.2.1.3	A3 Two-Watt Amplifier (Schematic 10032110)	39
3.2.2	A3, A4, A5 Four-Way Splitter	39
3.2.2	A19 Thru A30 Two-Way Splitter	39
3.2.3	A2, A7 thru A18 Driver Amplifiers (Schematic 10045386).....	40
3.2.4	A32 Dual Detector Assembly (Schematic 10033688)	40
3.2.5	Power Supplies, Driver Amplifier (PS1, PS2 AND PS3)	40
3.3	RF Amplifier Operation: 500 watt module Blocks A2-A24 (500 Watt Power Amplifier Schematic, 10045661)	41
3.3.1	A4 Two-Way Splitter	41
3.3.2	A5, A6 Four-Way Splitters	41
3.3.3	A7-A14 Final Amplifiers (Schematic 10036697).....	41
3.3.4	Power Supplies, 500 Watt Module Blocks (PS1 and PS2)	41
3.4	A26-A37 Sixteen-Way Combiners	42
3.5	A38 12-Way Combiner/BIDirectional Coupler	42
3.6	Power Distribution	42
3.7	Control System.....	42
3.7.1	Fiber-Optic System Control Link.....	42
3.7.2	Power On/Operate Circuits	43
3.7.3	Automatic Level Control Circuits	43
3.8	Fault Detection Circuits.....	44
3.8.1	Thermal Faults.....	44
3.8.2	Amplifier Faults	44
3.8.3	Power Supply Faults.....	44
3.8.4	ALC Fault.....	44
3.8.5	Interlocks.....	45
3.8.5.1	Inhibit Interlock	45
3.8.5.2	AC Interlock	45
3.8.6	System Error (F/O Link Fault).....	45
4.	TROUBLESHOOTING AND REPAIR.....	47
4.1	General	47
4.2	Fault Signal Interpretation and Diagnosis	47
4.2.1	Indicators For Troubleshooting	47
4.2.2	General - Reading Faults.....	47
4.2.3	Output Power Indicator	48
4.2.3.1	Controller Power Output Indicators.....	48
4.2.4	Power Supply Faults.....	48
4.2.5	Thermal Faults.....	48
4.2.6	ALC Fault.....	48
4.2.7	Amplifier Faults	48
4.2.8	Fiber-Optic System Control Fault	49
4.2.9	Fault Troubleshooting Guide.....	49
4.2.9.1	Model 10000W1000A Driver Amplifier Fault Troubleshooting Guide.....	49
4.2.9.2	Model 1000W1000A 500 watt Block Fault Troubleshooting Guide.....	49
4.3	Diagnosing and Replacing Amplifier Modules.....	50
4.3.1	Locating Modules within the 10000W1000A	50
4.3.2	Locating Modules within the 10000W1000A 500 Watt Blocks	51

Appendix A. Installing Software Upgrades	53
A.1 Firmware Updates.....	53
A.2 Control - Multi-Purpose Board Assembly Firmware (X1)	53
A.3 I/O - Input Output Board Assembly Firmware (X1)	54
A.4 Breakout - Piggy-Back Connected Switch Breakout Board (SBB) Assembly Firmware (X1)	54
A.5 Breakout - Fiber-Optic Connected Switch Breakout Board (SBB) Assembly Firmware In MPAs (X4).....	55
A.6 Automatic Leveling Control (ALC) Assembly Firmware (X1).....	55

1. GENERAL INFORMATION

1.1 GENERAL DESCRIPTION

The Model 10000W1000A is a self-contained, broadband solid-state amplifier designed for laboratory applications where instantaneous bandwidth, high gain, and moderate power output are required. A **GAIN** control, which is conveniently located on the unit's front panel, can be used to decrease the amplifier's gain by 25 decibels (dB) or more. Solid state technology is used exclusively to offer significant advantages in reliability and cost. A Model 10000W1000A, used with a frequency-swept signal source, will provide a minimum of 12,000 watts of swept power covering the frequency range from 80 to 700 MHz and a minimum of 10,500 watts of swept power from 700 MHz to 1000 MHz. Typical applications include antenna and component testing, wattmeter calibration, and electromagnetic interference (EMI) susceptibility testing, as well as usage as a driver for frequency multipliers and high-power amplifiers. The Model 10000W1000A can be operated locally by using the unit's front panel controls, or remotely by using the unit's IEEE-488, RS-232 interface, USB, or Ethernet interface.

- Special features incorporated into the Model 10000W1000A include the following:
- A **Digital Control Panel (DCP)** that allows both local and remote (via a computer interface) control of the amplifier (including adjustment of the amplifier's RF Gain during CW mode operation) and provides graphical displays of the amplifier's Forward and Reflected power levels.
- **Automatic Level Control (ALC)** by internal circuits; with front panel (via the unit's DCP) or remote (via the unit's computer interface) control of the ALC Threshold setting.
- **RF output level protection.**
- A **General Purpose Interface Bus (GPIB)/IEEE-488.2 interface** for remote control of the amplifier's operating functions.
- **RS232 serial communications** including both wire and fiber-optic ports for remote control.
- **USB Communication port** for remote control.
- **Ethernet Communication port** for remote control.
- **Protection** is provided by DC current limiting, over-temperature shut down and RF power limiting.

1.2 SPECIFICATIONS

Refer to the AR RF/Microwave Instrumentation Data Sheet at the end of this section for detailed specifications.

1.3 POWER SUPPLIES

The Model 10000W1000A is a modular design with each section having self-contained power supplies. These power supplies are self-contained, regulated switching units.

The A1 Driver amplifier contains three power supplies:

- The input voltage range to the power supplies is 120–240 VAC, 50-60Hz, selected automatically. The AC input power, combined for these two supplies is approximately 2000 watts.
- PS1 is a multiple output supply. The main +24 volts DC supplies drain voltage to the RF low level A1 and A2 modules. The +12 volts DC is for operating the cooling fans and the –12 volts DC is supplied to the A1, A2, A7–A18 RF modules. Primary AC circuit protection is provided by the circuit breaker in the Power Entry Module.
- PS2 and PS3 is a +24 volt, 24A switching power supply that supplies the drain voltage to modules A7-A18.

Each 500-watt module block (A2-A25) has a power supply providing approximately +24VDC as the main source of power for the amplifier circuitry. Also included in this unit is a +5V supply for logic and control functions and a +24V supply that runs cooling fans.

The Model 10000W1000A cabinet also contains two 3-phase power distribution units 360-435 VAC, 100 amp, 50/60Hz. These two units supply power to the A1 driver amplifier and the (24) 500-Watt blocks (A2 thru A25).

1.4 PROTECTION CIRCUITS

Features incorporated into this unit include RF output level protection circuits, thermal protection circuits, and internal DC level sensing and monitoring circuits that sense the voltage on each of the final and driver amplifier modules. There is protection for the AC main circuit. All switching supplies are short circuit protected. Reaching a threshold of either of the RF forward (incident) or reverse (reflected) power limit adjustment, which is adjusted to approximately 13,500 watts and 6000 watts respectively, will initiate limiting, or smooth drive level fold-back, in a low-level stage of the amplifier chain. If the limiting circuits cannot keep the amplifier's levels below the limit threshold, the protection circuits will invoke a shutdown of the main power supplies and low-level driver in the amplifier. Power amplifier modules are monitored for both over-current and under-current. A **RESET** function is provided to permit re-powering of the amplifier in case of transient or temporary activation of the amplifier's protection circuitry. The low-level driver and output amplifier subassemblies are thermally monitored.

The digital control panel monitors all fault signals, stores and displays any that are invoked and asserts the required action.

1.5 INSTALLATION

Before proceeding, thoroughly inspect the amplifier for signs of physical damage that may have been incurred during shipment and completely read the following installation and operating instructions, paying special attention to all **CAUTION** notes. See Section 1.5.2 for electrical power cord installation.

1.5.1 Location

Select an operating location that will permit air to circulate freely around the amplifier's cabinet. The Model 10000W1000A utilizes air cooling and should be located where the normal flow of air into or exiting from the unit will not be restricted, diverted, or re-circulated through the unit itself; in particular, the flow of warm air exiting the rear of the amplifier should not be impeded.

Do not position the unit next to a wall or other equipment that would restrict the flow of air into the bottom of the unit or out of the rear of the unit.

1.5.2 AC Power

The Model 10000W1000A is equipped with two Power Distribution Units designed for a five-wire, three-phase Wye connection: the five wires are for the three phases, the neutral, and a safety ground (GND). The primary input voltage range is 360-435 VAC. A 100-amp common trip circuit breaker located on both power units is used to supply power to The Model 10000W1000A.

CAUTION:



Dangerous voltages are present in the amplifier whenever plugged into an AC outlet. Always disconnect the AC power line to the amplifier before servicing the unit.

Due to the variety of power systems available internationally, line cords are not shipped with this unit. The user must determine and install the appropriate line supply to the unit. To install the line cord, first remove the four screws that hold the AC power input cover in place. Carefully lay the panel down horizontally to gain access to the AC Power terminal block. Prepare a line cord capable of safely supplying 100 amps or more and insert the line cord through the Romex strain relief on the AC power input cover.

Figure 1-1 shows how to properly connect the wires. Tighten the Romex strain relief and reinstall the cover using the four screws removed previously.

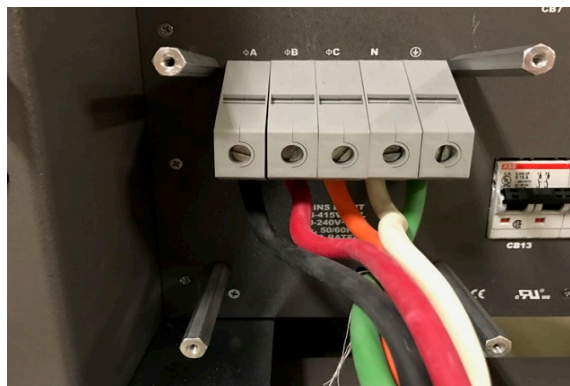

Figure 1-1. AC Line Cord Installation

1.5.3 Main Power

The Main Power AC circuit breaker is located on the rear panel of the power distribution box. Refer to rear panel drawing, Figure 1-2, for location. These route power to the individual 500 Watt module blocks and the Driver/Control. The power distribution provides accessory outlets for powering external test equipment. There are two 208VAC IEC outlets.

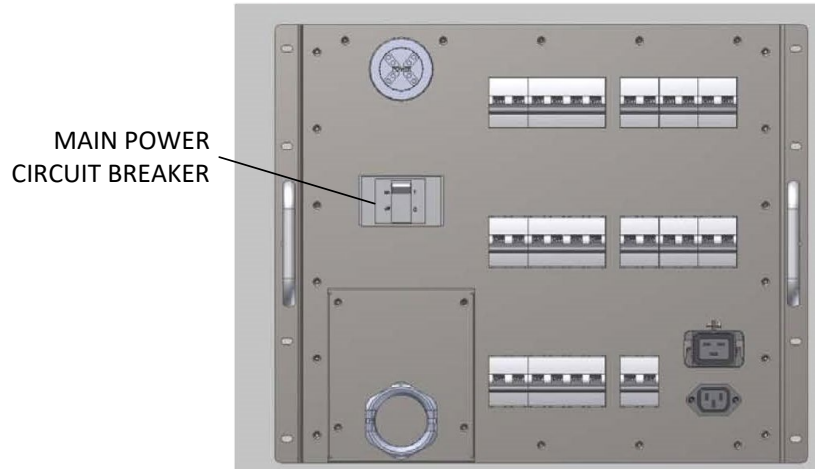

Figure 1-3. Rear panel of power distribution

1.5.4 Model 10000W1000A Controller Interconnections

- RF Outputs from the (A1) Driver amplifier to the RF Input of the (A2 thru A25) 500-Watt Blocks.
- RF outputs from the (A26 thru A37) 16-way combiners to the (A38) 12-way final combiner.
- 9-pin Sub-D AC interlock cables from the (A1) Driver amplifier to the (A2 thru A25) 500-Watt Blocks.
- Fiber Optic System control RX and TX Interface on the Model 10000W1000A driver amplifier to the 500-Watt Block's Fiber Optic Remote Interfaces.

NOTE: The Rear Panel Interlock Connection of the Model 10000W1000A must be closed to operate the Model 10000W1000A.

NOTE: All the above RF cables, Fiber optic, 9 pin D-Sub, and Power Cord sets must be in place for the amplifier to operate. Reference interconnect diagram 10044214, and assembly drawings 10042514, 10044507 and 10044508 for interconnections.

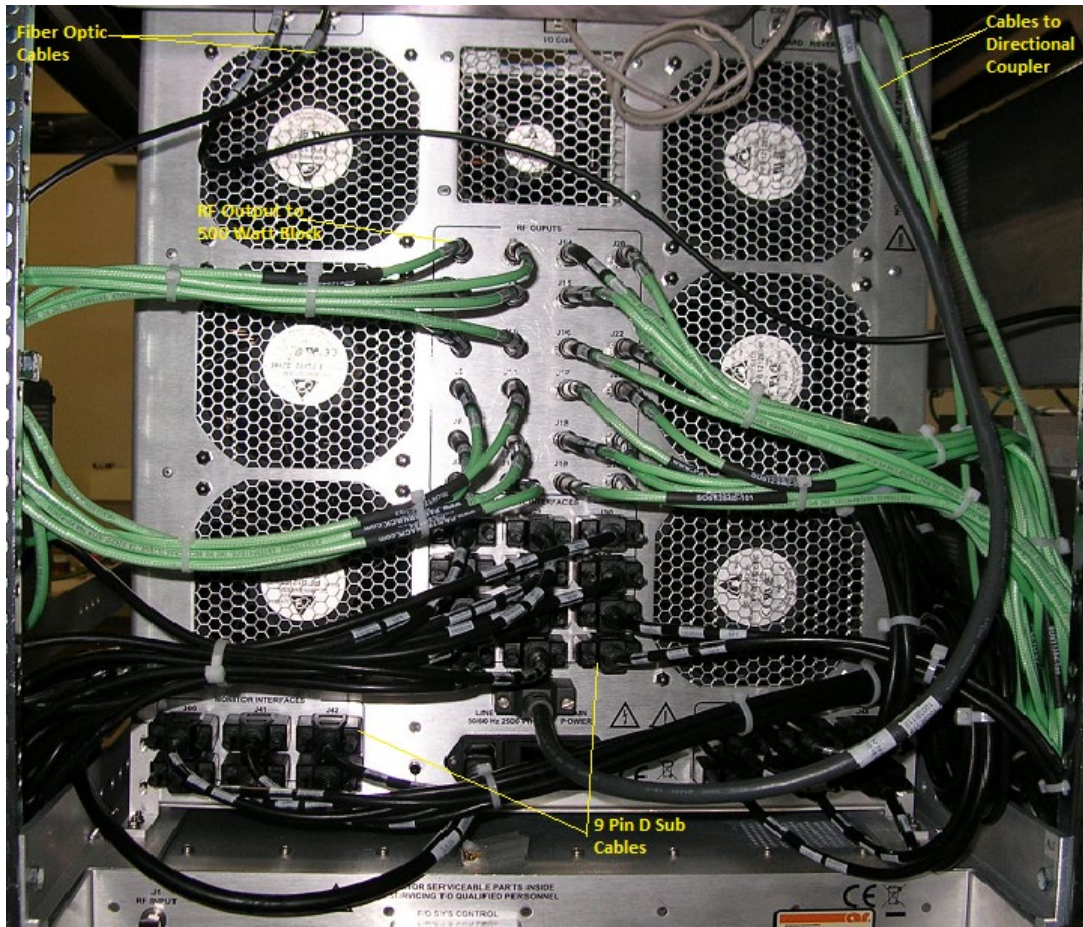

Figure 1-4. Model 1000W1000A Driver (Rear View)

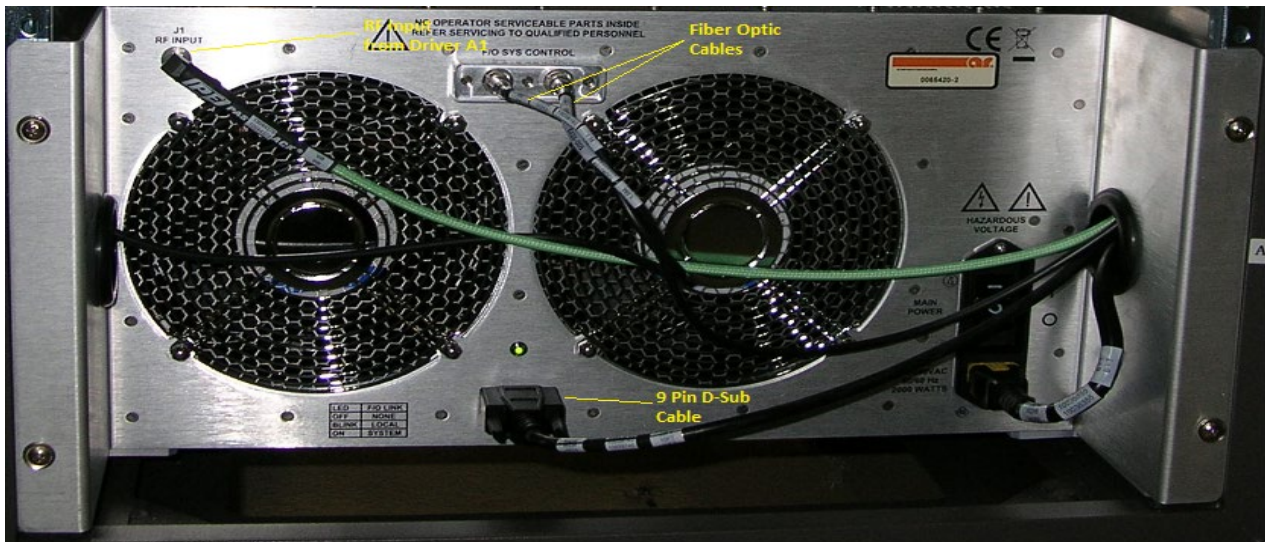

Figure 1-5. Model 1000W1000A 500 Watt Block (Rear View)

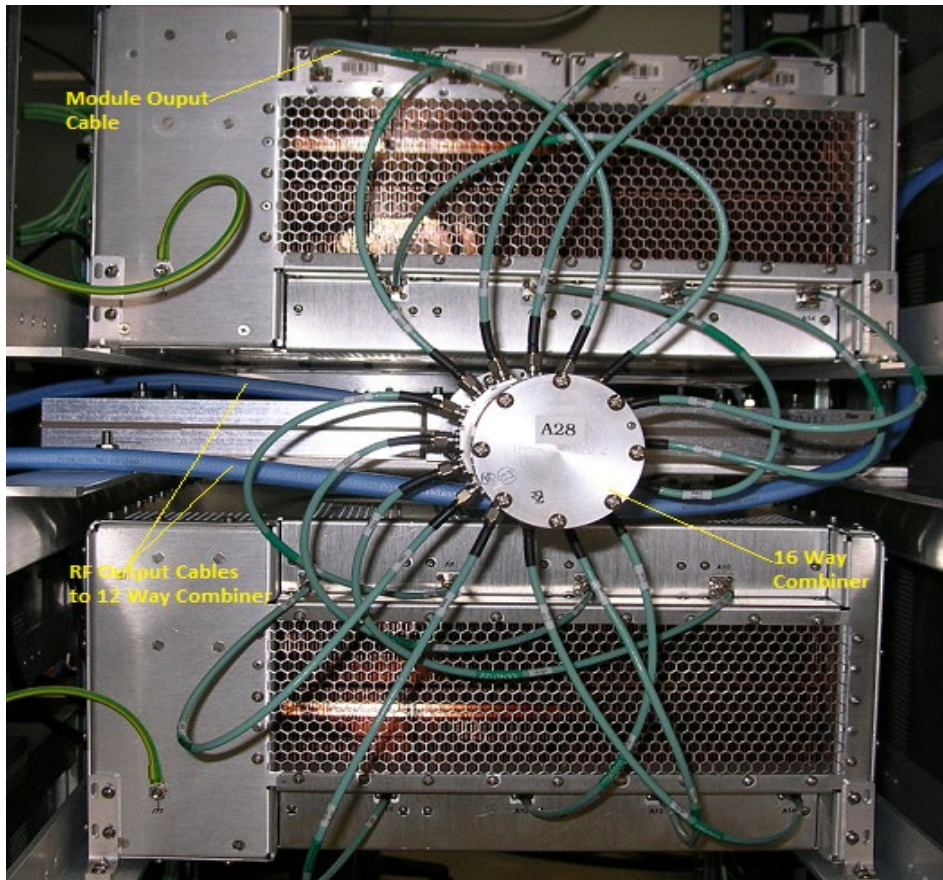

Figure 1-6. Model 10000W1000A 500 Watt Blocks (Front View)

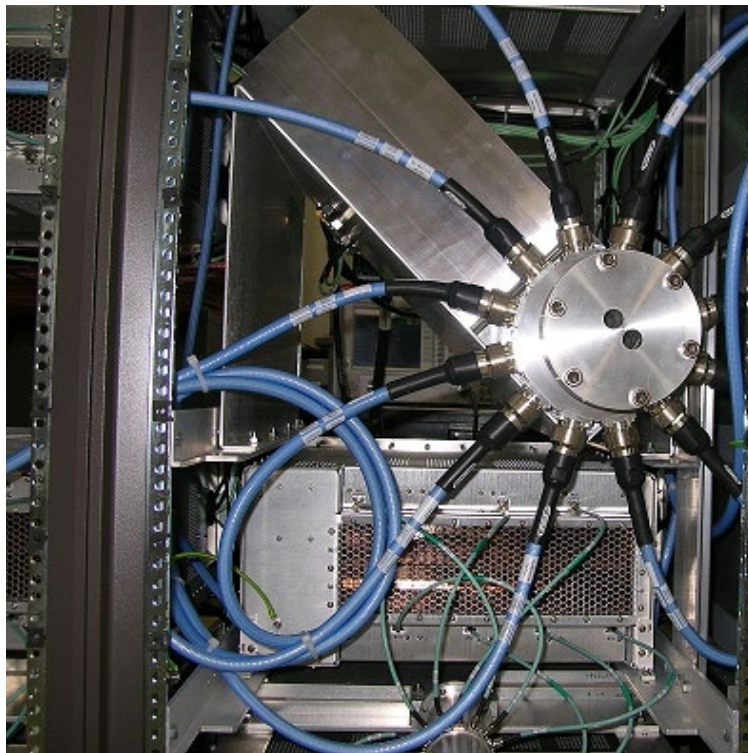

Figure 1-7. Model 10000W1000A 12 Way Combiner (Front View)

1.6 OTHER CONNECTORS

1.6.1 RF Input Connector

The RF input connector for the amplifier is located on the rear of the (A1) Driver amplifier.

1.6.2 RF Sample Ports

The Forward and Reverse power sample port connectors are located on the front of the (A1) Driver amplifier. Cables and equipment connected to these ports should exhibit resistive 50-ohm impedance throughout the band. They are normally used for operating external power meters. A calibration table is provided with the Model 10000W1000A that provides a list of external RF power meter offset values. The offset values completely characterize the directional coupler/forward sample port circuit attenuation across the frequency band, and are available in electronic form.

1.6.3 RF Output Connector

1.6.3.1 10kW Output

The amplifier RF output connector is a Type EIA 4 1/16" female located on the rear of the amplifier.

CAUTION:



Placing the amplifier in the Operate (RF On) mode without a load connected to the output connector is not recommended. Always shut off the amplifier prior to removing hardware connections.

1.6.4 Safety Interlock Connector

Located on the rear of the amplifier and directly behind the (A1) Driver amplifier, is the amplifier I/O panel, which includes remote interface connectors and safety interlock connectors. The 15-pin D-sub miniature female safety interlock connector provides two separate interlock loops. Pins 1 and 8 are used for situations where the amplifier can be left on, but forced into STANDBY (RF Off) mode. This interlock is called Inhibit Interlock. Pins 10 and 14 are used for situations that demand the safest possible condition, with the AC power to all main circuits disconnected. This interlock is called AC Interlock. Both loops must be closed, or jumpered, for normal operation.

1.6.5 Communications Connectors

The remote communication connectors are located on the Remote Interface panel assembly (schematic 10037770).

1.6.5.1 RS232 Wire

Standard 9-pin D-subminiature female connector

1.6.5.2 RS232 Fiber-optic

A pair of ST female bayonet connectors is provided, for transmit and receive.

1.6.5.3 IEEE-488

A standard 44-pin female IEEE-488 (GPIB) connector.

1.6.5.4 USB

A standard USB-B connector.

1.6.5.5 Ethernet

A standard Ethernet connector.



10000W1000A

- 10000 Watts CW
- 80MHz–1000MHz

Features

The Model 10000W1000A is a self-contained, air-cooled, broadband, completely solid-state amplifier designed for applications where instantaneous bandwidth and high gain are required. Push-pull circuitry is utilized in all high power stages in the interest of lowering distortion and improving stability. The Model 10000W1000A, when used with an RF sweep generator, nominally provides over 10000 watts of RF power.

The Model 10000W1000A is equipped with a Digital Control Panel (DCP) which provides both local and remote control of the amplifier. The DCP uses a color LCD touch screen and a single rotary knob to offer status reporting and control capability. The display provides operational presentation of Forward Power and Reflected Power plus amplifier status. Special features include a gain control, internal automatic level control (ALC) with front panel control of the ALC threshold, forward and reflective RF sample ports for precise power measurements and RF output level protection. Protection is provided by DC current level sensing of all output stages.

All amplifier control functions and status indications are available remotely in GPIB/IEEE-488 format and RS-232 hardware and fiber optic, USB and Ethernet. The buss interface connector is located on the back panel and positive control of local or remote operation is assured by a keylock on the front panel of the amplifier.

The Model 10000W1000A, housed in an equipment rack, provides readily available RF power for typical applications such as RF susceptibility testing, antenna and component testing, watt meter calibration, and as a driver for frequency multipliers and higher power amplifiers. A safety interlock can be implemented via a rear panel connector.

The export classification for this equipment is EAR99. These commodities, technology or software are controlled for export in accordance with the U.S. Export Administration Regulations. Diversion contrary to U.S. law is prohibited.

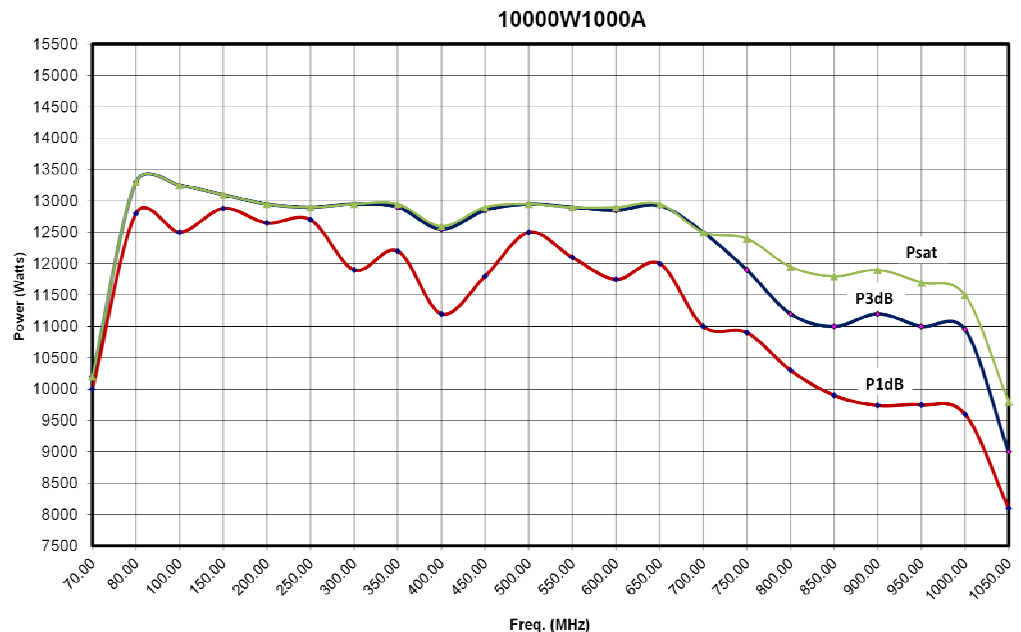

AR RF/Microwave
Instrumentation
160 School House Rd
Souderton, PA 18964
215-723-8181

For an applications engineer call: 800.933.8181

www.arworld.us



10000W1000A

- 10000 Watts CW
- 80MHz-1000MHz

Specifications

RATED OUTPUT POWER:

Nominal, 12500 watts
12000 watts minimum up to 700 MHz
10500 watts minimum, 700-1000 MHz

INPUT FOR RATED OUTPUT: 1.0 milliwatt maximum

POWER OUTPUT @ 3 dB compression:

Nominal 12500 watts, 12000 watts min up to 700 MHz, 10000 watts from 700 to 1000 MHz

POWER OUTPUT @ 1 dB compression:

Nominal 11000 watts, 10500 watts min up to 700 MHz; 9500 watts min from 700 to 1000 MHz

FLATNESS: ±2.0 dB maximum; ±1.5 dB typical

FREQUENCY RESPONSE: 80-1000 MHz instantaneously

GAIN (at maximum setting): 70 dB minimum

GAIN ADJUSTMENT (continuous range): 25 dB minimum

INPUT IMPEDANCE: 50 ohms, VSWR 1.5:1 maximum; 1.3:1 typical

OUTPUT IMPEDANCE: 50 ohms nominal

MISMATCH TOLERANCE: 100% of rated power without foldback, up to 6.0:1. Mismatch above which may limit to 6000 watts reflected power. Will operate without damage or oscillation with any magnitude and phase of source and load impedance. *See Application Note #27.

MODULATION CAPABILITY: Faithfully reproduces AM, FM, or Pulse modulation appearing on input signal.

HARMONIC DISTORTION: Minus 20 dBc maximum at 10000 watts, -25 dBc typical @ 10000 watts

THIRD ORDER INTERCEPT POINT: 78 dBm typical

NOISE FIGURE: 8 dB maximum, 6 dB typical

PRIMARY POWER (specify voltage):

200-240 VAC Delta connected (4-wire),
360-435 VAC Wye connected (5-wire)
50/60 Hz, three phase, 48000W

CONNECTORS

RF Input: Type N female, rear panel
RF Output: Type 4-1/16 EIA, rear panel

Forward sample: N female, front (-70 dBc)

Reverse sample: N female, front (-70 dBc)

Remote Interfaces:

IEEE-488 24-pin female

RS-232 9-pin Subminiature D, female

Fiber Optic ST Conn Tx and Rx RS-232

USB 2.0 Type B

Ethernet RJ-45

Safety Interlock: 15-pin Subminiature D, rear panel

COOLING: Forced air (self contained fans), enters front and bottom

SYSTEM (2 3-bay racks):

WEIGHT (approximate): 1407 kg (3100 lbs)

SIZE (W x H x D): 340 x 183 x 99 cm (134 x 72 x 39 in)

ENVIRONMENTAL:

Operating Temperature: 5°C / +40°C

Operating Altitude: Up to 2000M

Shock and vibration: Normal Truck Transport

REGULATORY COMPLIANCE:

EMC EN 61326-1

Safety UL 61010-1

CAN/CSA C22.2 #61010-1

CENELEC EN 61010-1

RoHS DIRECTIVE 2011/65/EU

EXPORT CLASSIFICATION: EAR99

Graphs

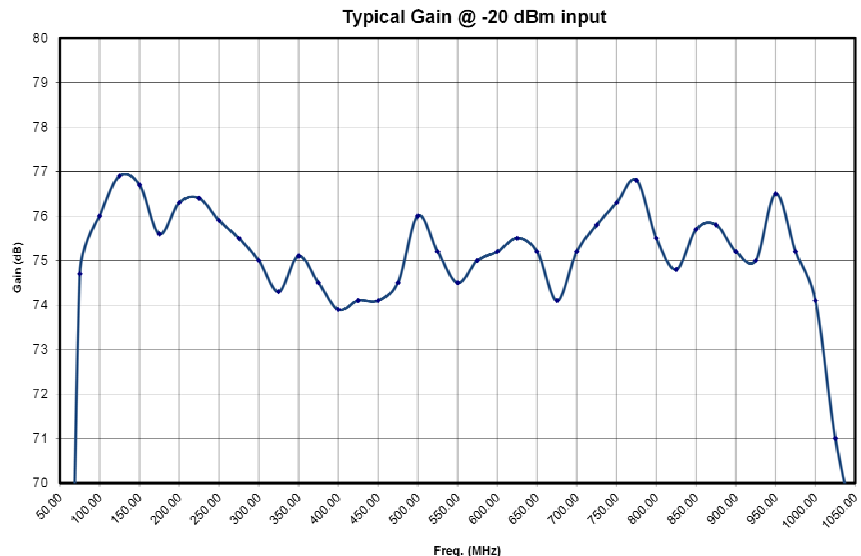

10000W1000A

- 10000 Watts CW
- 80MHz-1000MHz

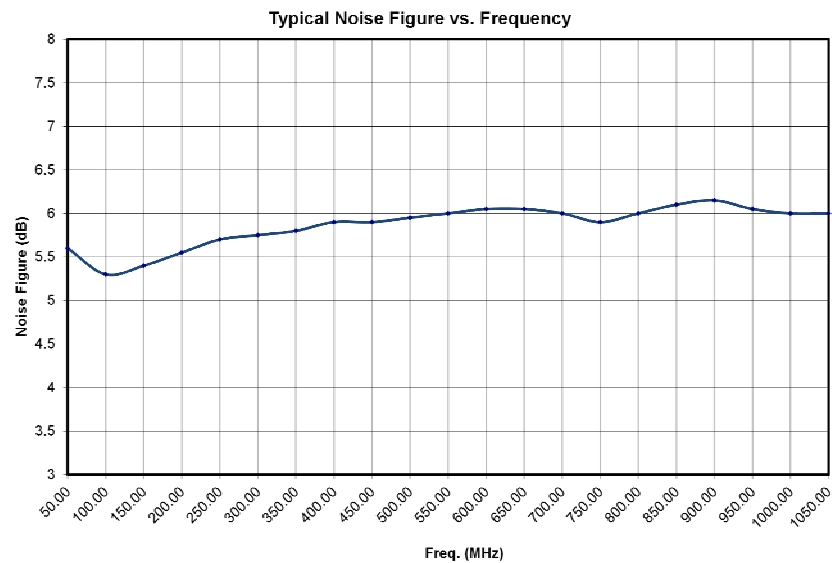
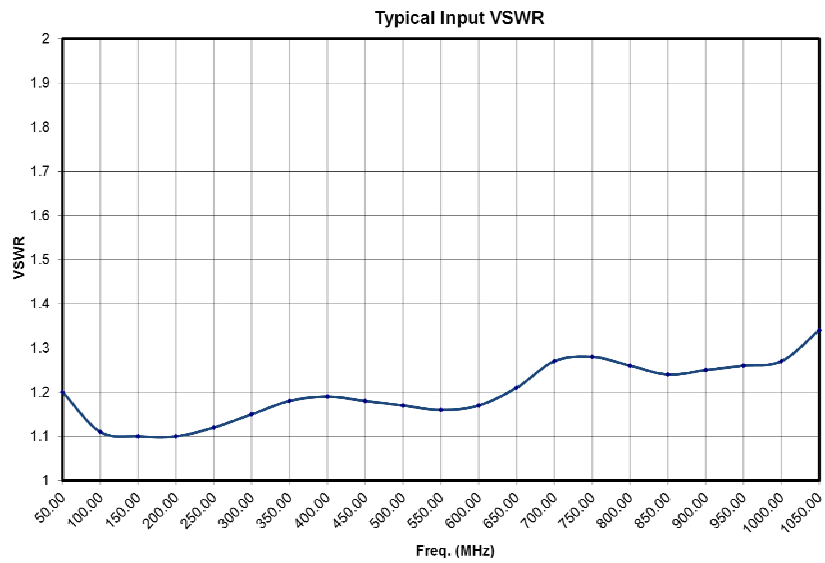
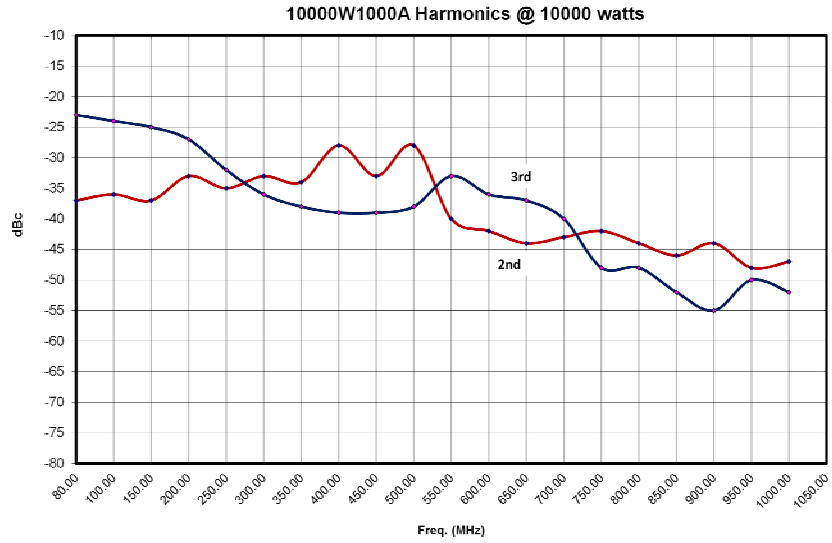

2. OPERATING INSTRUCTIONS

2.1 GENERAL

Operation of the Model 10000W1000A broadband amplifier is quite simple. The amplifier's input signal, whether swept or fixed in frequency, is fed into the jack marked **RF INPUT**, located on the rear of the amplifier, and the amplifier's output signal is taken from the jack labeled **RF OUTPUT**. The unit is turned on by activating the front panel **POWER** switch. In the event of a major malfunction, protection is provided by a circuit breaker located on the unit's rear panel.



CAUTION:

The Model 10000W1000A Amplifier is *typically* not critical in regard to source and load Voltage Standing Wave Ratio (VSWR) and will remain unconditionally stable with any magnitude and phase of source and load VSWR. However, placing the amplifier in the operate mode without a load connected to the output connector is not recommended. It has also been designed to withstand, without damage, RF input power levels up to twenty (20) times its rated input of 1mW. However, signal levels higher than 20mW or transients with high peak voltages can damage the amplifier. Also, accidental connection of the Model 10000W1000A's output to its input (either through direct connection or parasitic feedback paths) will cause oscillations that may permanently damage the unit's input transistors.

The Model 10000W1000A is protected from input overdrive by an automatic level control circuit. The Model 10000W1000A RF power transistors are protected from over temperature by sensing the chassis temperature near the RF output transistors. In the event of a cooling fan failure or an airflow blockage, the DC voltage will be removed from the RF stages, when the chassis temperature reaches approximately 70°C.

Normal operation can be resumed after the chassis temperature drops below 70° C.

2.2 SYSTEM OVERVIEW

The Model 10000W1000A amplifier has the following main interfaces: an RF input, an RF output, an electrical power input, and operator control.

There are two classifications of interfaces for operator control. These classifications are local and remote. The control panel located on the front of the driver rack is used for local and remote control of the Model 10000W1000A. This is accomplished through a touch-based Liquid Crystal Display (LCD).

This overview describes each of the interfaces and provides the details for controlling the Model 10000W1000A using both local and remote interfaces.

2.3 INTERFACE IDENTIFICATION AND DIAGRAMS

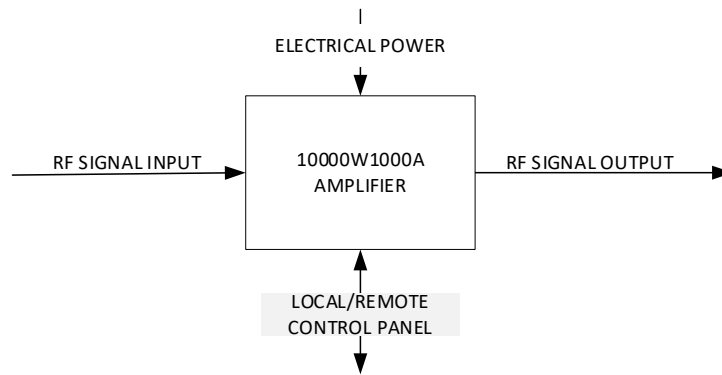

Figure 2-1. Model 10000W1000A Interface Block Diagram

2.4 RF INPUT

Input to the Model 10000W1000A or sub-amplifiers is accomplished through a female N-Type RF connector (50 ohm) found on the rear remote interface panel.

2.5 OPERATOR COMMAND AND CONTROL INTERFACE

This section describes the local and remote interface control of the Model 10000W1000A amplifier and/or sub-amplifiers. The Keylock switch on the control panel of the driver rack is used to select between three control options for the Model 10000W1000A. The Keylock switch on the control panel of each of the sub-amplifier is used to select between three control options for the associated sub-amplifier when they are run as sub-amplifier. The three control options are Local, Remote and Inhibit.

The Local option allows for control of the Model 10000W1000A amplifier or sub-amplifiers using the corresponding control panel. The Remote option allows for control of the Model 10000W1000A amplifier. The Inhibit option allows the Model 10000W1000A amplifier to be placed into a locked state preventing both local and remote control.

Figure 2-2 shows the state diagram for the Power and RF states of the Model 10000W1000A. This diagram should be used to understand the major states that the Model 10000W1000A can be in. For simplicity of the diagram, the Keylock switch position is only listed where relevant.

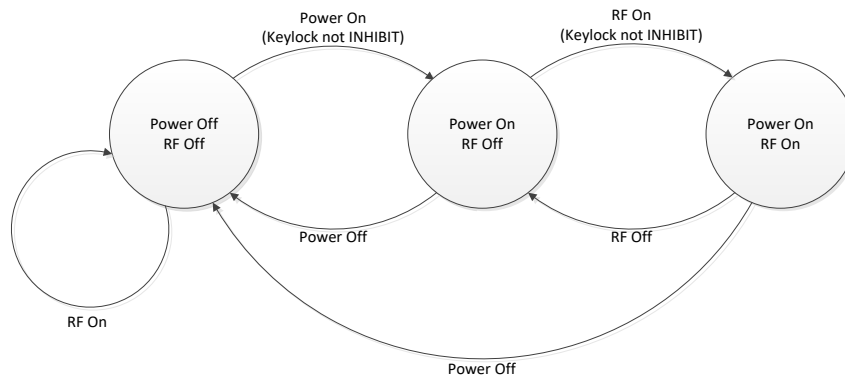

Figure 2-2. Control State Diagram

2.5.1 Local Control Interface

This section describes local operation of the Model 10000W1000A amplifier using the human interface items found on the corresponding control panel.



Figure 2-3 Digital Control Panel (DCP) Features

Item	Title	Function
1	INHIBIT, LOCAL, REMOTE	Keylock Switch, 3-position; key removal in INHIBIT position only
2	POWER	POWER control with indicator LED
3	DISPLAY (TOUCH SCREEN)	Numerous parameter values and fault messages, plus manual input control
4	ADJUST	Adjust knob to change selected variables
5	RF INPUT	Type N female connector
6	FWD Sample Port	Type N female connector
7	REV Sample Port	Type N female connector

2.5.1.1. Keylock Switch

The Keylock Switch is provided for protection from unauthorized use or unexpected remote control. The amplifier or sub-amplifiers can only be turned on locally when the Keylock Switch is in the LOCAL position. Likewise, the amplifier or sub-amplifiers can only be turned on or controlled remotely when the Keylock Switch is in the REMOTE position. Placing the Keylock Switch in the INHIBIT position places the amplifier or sub-amplifiers into an RF off state and prohibits any control. All remote queries are processed and responded to in any of the three Keylock switch positions.

2.5.1.2 Power Button

The momentary POWER button turns the main power to the Model 10000W1000A amplifier depending on the control panel. The status of the green light-emitting diode (LED) in the switch indicates whether the power is on or off. The main power supply fans are active when power is on. The LCD touch display is active as long as the main circuit breaker for the corresponding rack power entry module is on.

CAUTION:



It is recommended to leave the Model 10000W1000A in a standby (RF OFF) condition to allow the internal components to cool and stabilize after using in RF ON for periods greater than 10 minutes. Recommended standby (RF Off) time is one minute prior to powering off.

2.5.1.3 Adjust Knob

The ADJUST knob is used to set the value of several parameters available through the touch screen menu options. These parameters are RF Gain, ALC Threshold, ALC Detector Gain, and ALC Response. The Select Menu is used to select which parameter the ADJUST knob is able to adjust. The range of RF Gain, ALC Threshold, and ALC Detector Gain is 0 to 100 percent. The range of the ALC Response is 0 to 7. The ADJUST knob can be rotated both clockwise and counterclockwise 360 degrees.

2.5.1.4 Touch Screen

The touch screen is a color LCD that can accept single touch events from soft blunt objects such as a human finger. The mechanism that registers touch events is resistive-based and relies on pressure not capacitance. Menu options presented on the touch screen are typically gray in color with a black text label in the center. When a valid touch event is registered, a thin black box appears around the valid touch location and an optional audible beep will occur.

2.5.1.5 Menu Map

Figure 2-4 shows the menu map for the Model 1000W1000A. The screens depicted are only example screens. The actual values and settings will be different on the actual amplifier depending on user settings and operating conditions.

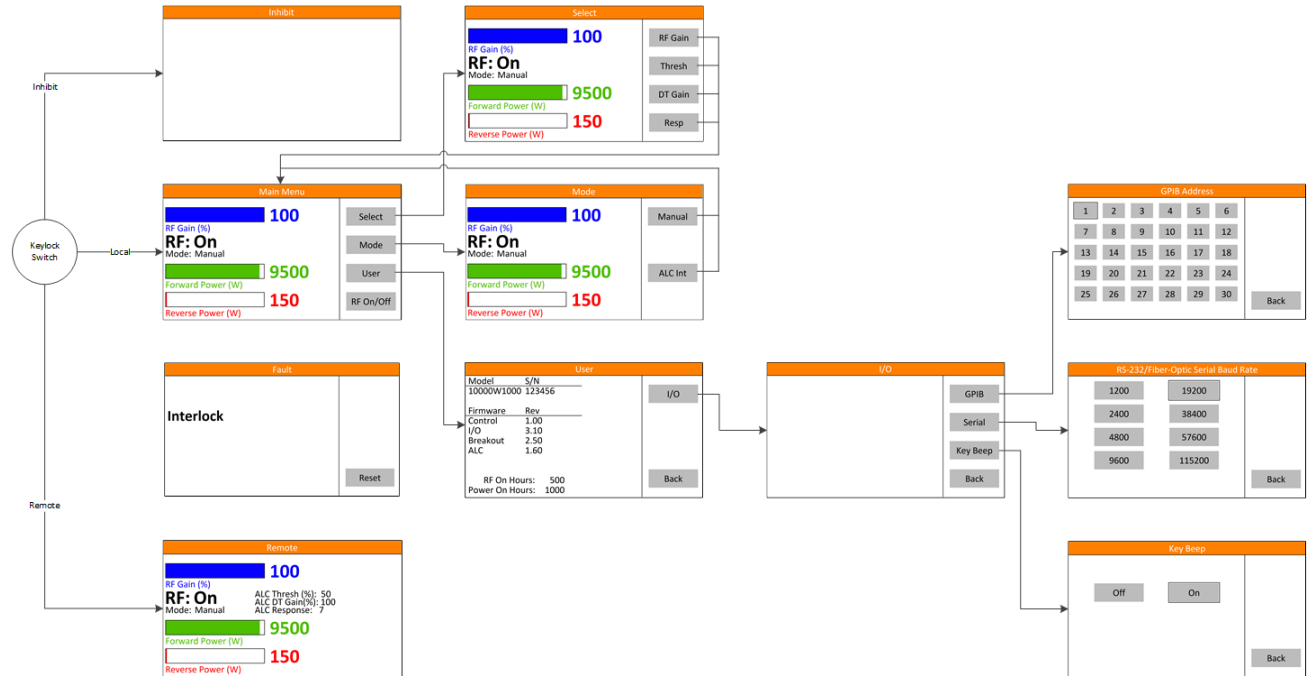

Figure 2-4. Menu Map

2.5.1.5.1 Inhibit Screen

The Inhibit screen is used as an indication to the user that the Model 1000W1000A is in an inhibited mode. In inhibit mode the POWER button cannot be used, and no touch screen menu options are available. In addition, the ADJUST knob is disabled.



Figure 2-5. Inhibit Screen

2.5.1.5.2 Main Menu Screen

The Main Menu screen is only available when the Keylock switch is in the LOCAL position.

At the top of the screen is the RF Gain, ALC Threshold, ALC Detector Gain, or ALC Response value in the form of a blue bar graph and associated blue numeric value. See Section 2.5.1.3 for range information.

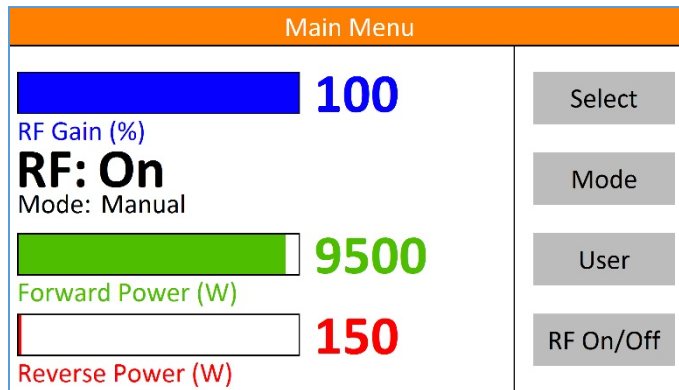

Figure 2-6. Main Menu Screen

In the left center of the screen is the Automatic Leveling Control (ALC) Mode which can be Manual/Continuous Wave (CW) or ALC Internal.

The RF state is shown in bold lettering which can be either Off or On.

At the bottom of the screen are the forward and reverse power indicator bar graphs and associated values in watts. The scale of the bar graphs is based on a range of 0 to rated power. For the Model 10000W1000A rated power is 10000 watts. The forward power is indicated in green while the reverse power is indicated in red.

The menu options available from the main menu are Select, Mode, User, and RF On/Off.

Select brings up the selection menu for the assignment of the ADJUST knob. Mode brings up the menu for the selecting the ALC mode. User brings up the User screen and menu.

RF On/Off enables or disables the RF path through the Model 10000W1000A. Pressing RF On will put the Model 10000W1000A into an RF ON state.

2.5.1.5.3 Select Screen

The Select screen is the same as the Main Menu screen with the exception of the menu options. The menu options in this screen allow the user to select what parameter the ADJUST knob can adjust. Once a selection is made, the screen will automatically change back to the Main Menu screen. The blue bar graph and associated value will change to reflect the value of the selected item.

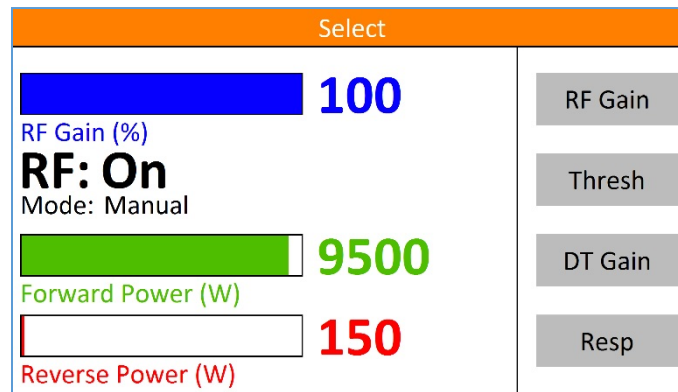

Figure 2-7. Select Screen

2.5.1.5.4 Mode Screen

The Mode screen is the same as the Main Menu screen with the exception of the menu options. The menu options in this screen allow the user to select the ALC mode. Once a selection is made, the screen will automatically change back to the Main Menu screen. The Mode indicator will change to reflect the selected mode.

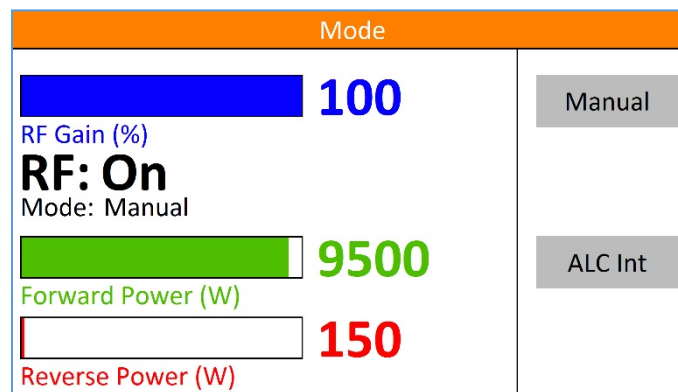

Figure 2-8. Mode Screen

2.5.1.5.4.1 Automatic Level Control (ALC) Mode

In this mode, the amplifier is operated in an Automatic Leveling mode, that is, the amplifier's RF output level is controlled by the THRESHOLD, RF GAIN and DETECTOR GAIN controls. The ALS input (feedback) for this mode uses the internal detector to achieve an output flatness of ± 1 dB.

2.5.1.5.4.2 THRESHOLD Control

This control is used to adjust the output RF signal level in the ALC mode only; leveling will not occur if there is not sufficient RF input power to the amplifier. The Threshold control is not used in the Manual or Pulse modes.

To adjust the ALC Threshold, select the ALC operating mode. Press the **THRESH** button. Adjust the value using the adjust knob. Please note that the display panel is limited in resolution compared to the control signals, which are generated and sent to the ALC Threshold control electronics. A small rotation that may not show any change on the display may, in fact, cause very small, precise changes in the amplifier’s RF output.

2.5.1.5.4.3 DETECTOR GAIN Control

This control is used to compensate for gain variations of the ALC loop caused by differences in the detectors that can be used to provide level feedback to the automatic leveling loop.

To adjust the ALC Detector Gain, select the ALC operating mode. Press the **DGAIN** button. Adjust the value using the knob. Please note that the display panel is limited in resolution compared to the control signals, which are generated and sent to the Detector Gain control electronics. A small rotation that may not show any change on the display may, in fact, cause very small, precise changes in the Detector Gain. For Internal ALC operation, this control may be set to approximately 50%. If more precise leveling is desired, the Detector Gain may be set up to 100%.

2.5.1.5.4.4 ALC RESPONSE Control

The ALC RESPONSE control is used to adjust the frequency response of the ALC loop. This control is particularly useful if the input to the amplifier is a swept signal. By adjusting the speed of the ALC loop, critical damping-without oscillation-can be obtained. A level of 1 is the fastest time constant and a level of 6 is the slowest.

2.5.1.5.5 User Screen

The User screen presents the user with the revision levels of all the firmware that is running on all the main control system components. For the Switch Breakout Board (SBB) assemblies the piggy-back assembly firmware is listed. At the bottom of the screen the RF On and Power On Operating Hours are displayed. A menu option is provided for accessing the settings for the remote I/O ports found on the rear panel of the driver rack.

User	
Model	S/N
10000W1000A	123456
Firmware	Rev
Control	1.00
I/O	3.10
Breakout	2.50
ALC	1.60
RF On Hours:	500
Power On Hours:	1000

I/O

Back

Figure 2-9. User Screen

2.5.1.5.6 I/O Screen

The I/O screen is used to present the user with menu options pertaining to the remote I/O ports found on the rear of the driver rack and the interaction with the touch screen. These options include the GPIB address, RS-232/Fiber-Optic Serial Baud Rate, and key beep.

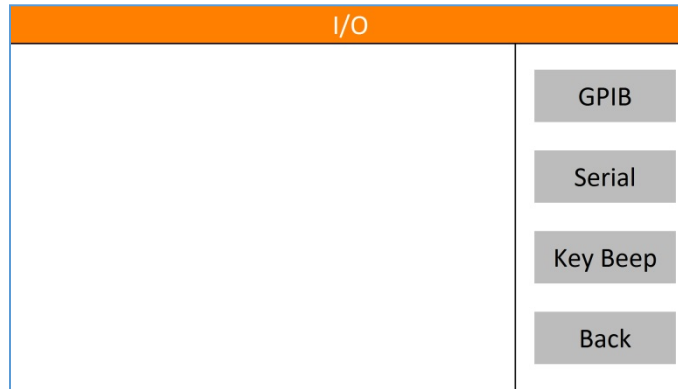

Figure 2-10. I/O Screen

2.5.1.5.7 GPIB Address Screen

The GPIB address screen is used to select the GPIB address. Touching any of the buttons labeled 1 to 30 immediately sets the GPIB address to the corresponding value. A thin black outline indicates the present GPIB address selection. When the back button is pushed the address selection is stored to non-volatile memory. Therefore, if power is lost prior to hitting the back button any address selection changes will be lost. The default GPIB address is 1.

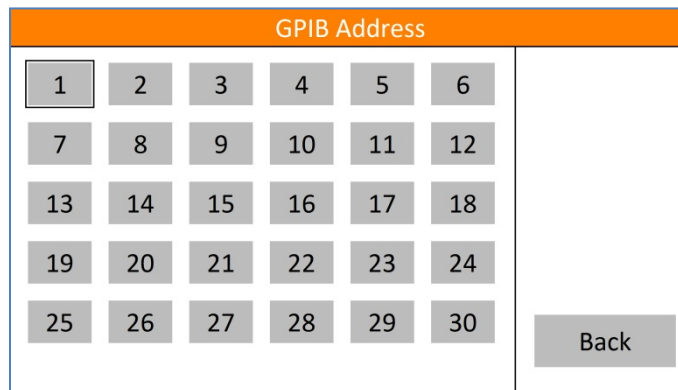

Figure 2-11. GPIB Address Screen

2.5.1.5.8 RS-232/Fiber-Optic Serial Baud Rate Screen

The RS-232/Fiber-Optic Serial Baud Rate screen is used to select the baud rate used by both the RS-232 port and the Fiber-Optic Serial port. A thin black outline indicates the present baud rate selection. When the back button is pushed the baud rate selection is stored to non-volatile memory. Therefore, if power is lost prior to hitting the back button, any baud rate selection changes will be lost. The default baud rate is 19200.

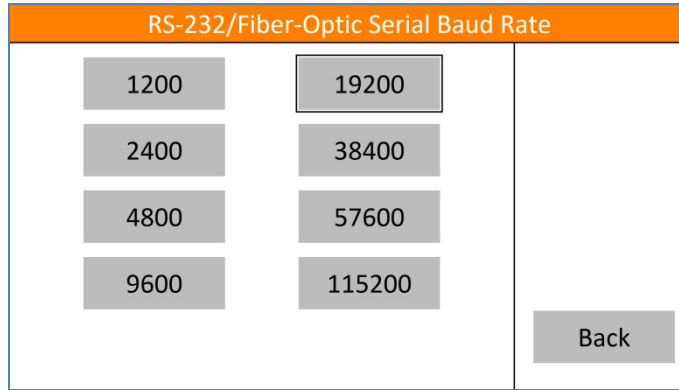

Figure 2-12. RS-232/Fiber-Optic Serial Baud Rate Screen

2.5.1.5.9 Key Beep Screen

The Key Beep screen allows the user to turn on or off the audible beep that occurs when a valid touch event takes place. This setting is only stored in volatile memory and will be lost when power to the driver rack is cycled. The default value for this setting is On.

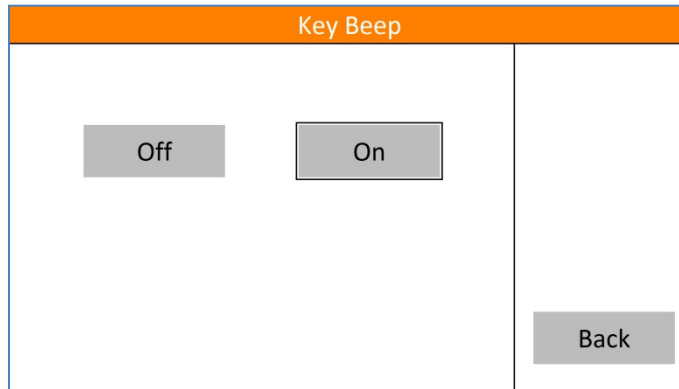

Figure 2-13. Key Beep Screen

2.5.1.5.10 Remote Screen

When the Keylock switch is set to the REMOTE position the Remote screen appears. This screen has all the same information as the Main Menu screen except that the blue bar graph and associated value are only for the RF Gain value. Because of this, the ALC Threshold, ALC Detector Gain, and ALC Response values are displayed separately in black toward the center of the screen.

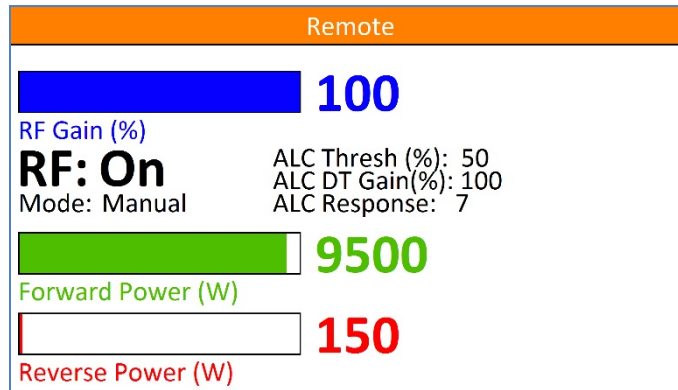

Figure 2-14. Remote Screen

2.5.1.5.11 Fault Screen

The Fault screen will appear anytime that a fault condition is met. The name of the fault is shown toward the center of the screen. In either LOCAL or REMOTE Keylock switch positions, a Reset button will appear allowing local resetting of the fault condition. Faults can also be reset remotely. If the fault reset is successful, the screen will return to the Main Menu or Remote screen depending on the Keylock switch position.



Figure 2-15. Fault Screen

2.5.2 Remote Control Interface

This section describes remote operation of the Model 10000W1000A using the provided General Purpose Interface Bus (GPIB), RS-232, Fiber-Optic Serial, Universal Serial Bus (USB), and Ethernet ports connected to a remote device such as a personal computer. All ports are active at all times; however, only one port may be used at a time. Communicating through two or more ports at one time will cause data collisions and lost commands or queries.

The Keylock switch on the control panel of the Model 10000W1000A allows it to be controlled using remote communications. All remote queries will work in any Keylock switch position, but all remote commands will only work when the position is set to REMOTE. When the Keylock switch is set to REMOTE all front panel controls are disabled unless otherwise specified.

Due to the high power output capability of the Model 10000W1000A there is a built-in safety mechanism while the Keylock switch is in the REMOTE position. Once the RF is instructed to go to an on state, it is necessary to continually communicate over any of the remote I/O ports on a periodic basis. The timing for this periodic basis is determined by the Remote Operate Timeout (ROPTO) command found in Section 2.5.2.6.16.

2.5.2.1 GPIB (IEEE-488) Communication

For GPIB operation, the device address is set using the front panel touch screen. Ensure that each device connected to the GPIB is set to a unique address.

To send commands be sure that the Model 10000W1000A's address is set properly and that the controller has correctly identified it as a "listening" device.

When sending commands via the GPIB interface, terminate with an EOI, a Line Feed character or both. The Model 10000W1000A will ignore characters following the termination.

2.5.2.1.1 Setting the GPIB (IEEE-488) Address

The GPIB device address can be set to any number between 1 and 30. This selection is made by navigating to the GPIB address selection screen (Section 3.3.1.5.7). To get there from the Main Menu, touch the User menu button followed by the I/O menu button and finally the GPIB menu button. Touching any of the buttons labeled 1 to 30 immediately sets the GPIB address to the corresponding value. A thin black outline indicates the present GPIB address selection. When the back button is pushed the address selection is stored to non-volatile memory. Therefore, if power is lost prior to hitting the back button any address selection changes will be lost. The default GPIB address is 1.

2.5.2.2 RS-232 Communication

The RS-232 port is a serial communications bus. All commands and queries through this port must be terminated with a Line Feed character. When a valid query is received, it is processed and the result is immediately transmitted back over the RS-232 interface. This port is designed to time-out if there is no activity on the bus for more than 5 seconds. At this time the internal buffer is cleared and a TIMEOUT_ERROR message followed by a Line Feed character is sent out from this port.

The baud rate for the RS-232 port is user selectable from the RS-232/Fiber-Optic Serial Baud Rate selection screen. To get there from the Main Menu, touch the User menu button followed by the I/O menu button and finally the Serial menu button. A thin black outline indicates the present baud rate selection. When the back button is pushed the baud rate selection is stored to non-volatile memory. Therefore, if power is lost prior to hitting the back button any baud rate selection changes will be lost. The default baud rate is 19200.

NOTE: This baud rate setting is shared by both the RS-232 port and the Fiber-Optic serial port.

The RS-232 port is setup as a Data Circuit-terminating Equipment (DCE) port. When connecting to a Personal Computer (PC) a straight one-to-one cable should be used. A null modem is NOT needed. The settings and pinout diagram for this port can be found below.

Table 2-1. RS-232 Port Settings

Word Length	8 bits
Stop Bits:	1
Baud Rate:	User selectable (default is 19200)
Parity:	None
HW Handshake:	None

Table 2-2. RS-232 (DCE) Port Pinout Diagram DB-9 Female

Pin 1	DCD
Pin 2	TD
Pin 3	RD
Pin 4	DTR
Pin 5	GND
Pin 6	DSR
Pin 7	CTS
Pin 8	RTS
Pin 9	Unused

2.5.2.3 Fiber-Optic Serial Communication

The Fiber-Optic port is a serial communications bus. All commands and queries through this port must be terminated with a Line Feed character. When a valid query is received, it is processed and the result is immediately transmitted back over the Fiber-Optic interface. This port is designed to time-out if there is no activity on the bus for more than 5 seconds. At this time, the internal buffer is cleared and a TIMEOUT_ERROR message followed by a Line Feed is sent out from this port.

The baud rate for the Fiber-Optic Serial port is user selectable from the RS-232/Fiber-Optic Serial Baud Rate selection screen. To get there from the Main Menu, touch the User menu button followed by the I/O menu button and finally the Serial menu button. A thin black outline indicates the present baud rate selection. When the back button is pushed the baud rate selection is stored to non-volatile memory. Therefore, if power is lost prior to hitting the back button any baud rate selection changes will be lost. The default baud rate is 19200.

NOTE: This baud rate setting is shared by both the Fiber-Optic serial port and the RS-232 port.

The Fiber-Optic port provides the user with the ability to optically isolate the controlling PC from the Model 10000W1000A. This can be useful in an environment where RF/Microwave energy could be coupled onto a connection to one of the “wired” communications ports and fed back to the controlling PC.

Both optical connections (TX and RX) are optimized to work with light at a wavelength of 820nm. For more detailed specifications on this port, consult the Avago HFBR series datasheet found at www.avagotech.com.

A glass, multi-mode, fiber-optic cable of 200um is recommended, however fiber-optic cable as small as 50um can be used. The connector type for this port is ST.

This port can be used in conjunction with either an AR Model IF7000 RS-232 to Fiber-Optic Interface (1200 to 9600 baud only) or an AR Model IF7001 USB to Fiber-Optic Interface (19200 baud only). Note that these devices use SMA connectors so a fiber-optic cable is needed with ST connectors on one end and SMA connectors on the other. This cable can be obtained from a fiber-optic cable distributor such as Fiber Instrument Sales (FIS). Their web-site can be found at www.fiberinstrumentsales.com. An example cable that will work for this connection is FIS Part Number D615M7FIS. The 7 in the part number refers to the length of the cable. In this case the length is 7 meters.

Table 2-3. Fiber-Optic Serial Port Settings

Word Length	8 bits
Stop Bits:	1
Baud Rate:	User selectable (default is 19200)
Parity:	None
HW Handshake:	None

2.5.2.4 USB Communication

The USB port is a USB 2.0 port. It also complies with the USB Test and Measurement Class (USBTMC) Standard. Communications with this port requires the host computer to have a USBTMC driver available. All commands and queries through this port must be terminated with a Line Feed character.

The cable required to make this connection is a USB 2.0 A-B peripheral device cable. The cable can be no longer than 5 meters. If a longer distance is required a USB hub must be used. A cable carrying the official USB logo is recommended.

When connected to a PC running Windows 2000 or XP a window will pop-up labeled Hardware Wizard. If this PC has National Instruments LabView installed it will have a USBTMC driver that will work with this port. This driver will allow the device to be easily controlled using National Instruments Measurement and Automation Explorer or LabView. It should be noted that the USBTMC driver provided by National Instruments is a Virtual Instrument Software Architecture (VISA) driver which can be used with other programming languages besides LabView. For more information on this please consult the National Instruments Website found at www.ni.com.

NOTE: All firmware updates are done through the USB port.

2.5.2.5 Ethernet Communication

The Ethernet port allows remote control through a Transmission Control Protocol (TCP) data channel. All commands and queries through this port must be terminated with a Line Feed character.

By default this port is setup to work on a network with a Dynamic Host Configuration Protocol (DHCP) server. Upon connection, an Internet Protocol (IP) address is assigned based on the internal Media Access Control (MAC) address. The MAC address is printed on a label located near the Ethernet port.

If the connected network does not have DHCP enabled then the device can be assigned an IP address by the user. To do this, download the utility called DeviceInstaller™ from www.Lantronix.com. For assistance using this utility please consult the utilities embedded help file.

The DeviceInstaller™ utility will scan the network and find all connected Lantronix Ethernet devices. This list of found devices will include any connected AR Ethernet devices. By selecting one of the connected devices from the list, its IP address and subnet mask can be changed along with a number of other settings. One should

use caution in adjusting any settings he/she is unfamiliar with as doing so may cause the port to become unresponsive. By default the port for the TCP data channel is 10001.

*DHCP is a protocol used to assign a dynamic IP address to a device. Network server software will assign an available IP address to a device when it is connected and powered on. Different IP addresses may be assigned at different times.

2.5.2.6 Remote Commands

- If a command or query is unrecognized it is echoed back out the port it came in on.
- All commands and queries are terminated with a Line Feed character.
- A Line Feed character is indicated by <LF> in subsequent command and query definitions.
- All queries can be sent when the Keylock switch is in the INHIBIT, LOCAL, or REMOTE position.
- All commands can only be sent when the Keylock switch is in the REMOTE position.
- All spaces in command and query definitions are indicated by <space>.
- If a query is recognized, its associated response is echoed out the port it came in on.

A COMMUNICATIONS_ERROR<LF> can occur if the time between commands or queries is too short, or the internal RS-485 link between the IO Board assembly and the Multipurpose Board (MPB) assembly is broken.

The development of application programs requires an understanding of the operation of the Model 10000W1000A as well as the intended application.

An application program on the computer/controller should issue only one character string (command or query) at a time. After each functional command is issued, the Model 10000W1000A's status should be checked to ensure that the command has been properly executed. The application program should allow sufficient time for the function to be completed before checking the status.

The application program should facilitate the checking of the status just prior to issuing a command, since the status could have been changed by a fault condition or by operator actions.

Variables represented by wild card characters i.e. x, y, z etc. do not indicate or delimit the number of characters actually specified.

Table 2-4. Relationship between the Model 10000W1000A Controls and Remote Communication

AC Power and Circuit Breaker		Power		Keylock Switch			Remote Communication	
On	Off	On	Off	INHIBIT	LOCAL	REMOTE	Command	Query
	√						X	X
√			√			√	√	√
√		√				√	√	√
√		√			√		X	√
√		√		√			X	√
√			√		√		X	√
√			√	√			X	√

X = No, √ = Yes

2.5.2.6.1 Power On/Off

This command controls the power on/off state of the Model 10000W1000A.

Max time to execute: 10mS

Syntax: **POWER:x**

Parameters: State(x):
OFF = power off
ON = power on

Response Format: None (No query for this command)

Example: To turn the power on, send the following command:

POWER:ON<LF>

To turn the power off, send the following command:

POWER:OFF<LF>

2.5.2.6.2 RF On/Off

This command controls the RF on/off state of the Model 10000W1000A.

Max time to execute: 5000mS

Syntax: **RF:x**

Parameters: State(x):
OFF = power off
ON = power on

Response Format: None (No query for this command)

Example: To turn the RF on, send the following command:

RF:ON<LF>

To turn the RF off, send the following command:

RF:OFF<LF>

2.5.2.6.3 Reset Faults

This will clear all faults, if possible.

Max time to execute: 100mS

Syntax: **RESET**

Parameters: None

Response Format: None (No query for this command)

Example: To clear any faults, send the following command:

RESET<LF>

2.5.2.6.4 Mode Select

This command sets the ALC mode of the Model 10000W1000A.

Max time to execute: 10mS

Syntax: **MODE:x**

Parameters: Mode(x):

MANUAL = Set to Manual/CW mode

ALC<space>INT = Set to ALC Internal mode

Response Format: None (No query for this command)

Example: To set the ALC mode to ALC Internal mode, send the following command:

MODE:ALC INT<LF>

2.5.2.6.5 Level Adjust

This command sets the RF gain, detector gain, ALC threshold, and ALC Response Time of the Model 10000W1000A.

Max time to execute: 10mS

Syntax: **LEVEL:xy**

Parameters: Parameter(x):

GAIN = RF Gain

DET = Detector Gain

THR = ALC Threshold

RESP = Response Time

Value(y):

For RF Gain, Detector Gain, and ALC Threshold:

0 = Minimum

100 = Maximum

For Response Time:

0 = Minimum

7 = Maximum

Response Format: None (No query for this command)

Example: To set the RF Gain to minimum, send the following command:

LEVEL:GAIN0<LF>

To set the RF Gain to 50%, send the following command:

LEVEL:GAIN50<LF>

To set the ALC Response Time to max, send the following command:

LEVEL:RESP7<LF>

2.5.2.6.6 Identity

Query to identify the Model 10000W1000A.

Max time to execute: 10mS

Syntax: ***IDN?**

Parameters: None

Query only (always requires a ? character)

Response Format: **f,m,n,<LF>**

Where:

f = manufacturer

m = model designation

n = firmware revision

Example: To get the identity of the Model 10000W1000A, send the following command:

***IDN?<LF>**

Response: **AR-RF/MICROWAVE-INST,10000W1000A,1.0<LF>**

2.5.2.6.7 IO Board Firmware Revision

Query to get the firmware revision of the I/O Board.

Max time to execute: 10mS

Syntax: ***IOB?**

Parameters: None

Query only (always requires a ? character)

Response Format: **INTERFACE_BOARD_SW_REVx<LF>**

Where:

x = firmware revision

Example: To get the firmware rev. of the I/O Board, send the following command:

***IOB?<LF>**

Response: **INTERFACE_BOARD_SW_REV3.10<LF>**

2.5.2.6.8 Machine State

This query reads the RF gain, detector gain, ALC threshold, and ALC response time of the Model 10000W1000A.

Max time to execute: 10mS

Syntax: **MSB?**

Parameters: None

Query only (always requires a ? character)

Response Format: **RF<space>GAIN=x,
DT<space>GAIN=x,
THRES=x,
RESP=y<LF>**

Value(x): [x is always 3 characters in length, padded with leading spaces]

For RF Gain, Detector Gain, and ALC Threshold:

0 = Minimum

100 = Maximum

Value(y): [y is always 1 character in length]

For Response Time:

0 = Minimum

7 = Maximum

Response Time Setting	Time (mS)
0	1
1	5
2	10
3	30
4	100
5	1000
6	3000
7	3000

Example: To get the machine state, send the following command:

MSB?<LF>

Response: **RF<space>GAIN=100,DT<space>GAIN=<space>50,THRES=<space>75,RESP=1<LF>**

(RF gain is 100%, Detector Gain is 50%, ALC Threshold is 75%, and ALC Response Time is set to 5mS)

2.5.2.6.9 State

Query to find the state of the Model 10000W1000A.

Max time to execute: 10mS

Syntax: **STATE?**

Parameters: None

Response Format: **STATE=<space>xyza<LF>**

Where: **x**, **y**, **z**, and **a** are each an ASCII character representing a hexadecimal character. They can be 0 to 9 or A to F.

Each hexadecimal character represents a 4-bit binary number. This 4-bit number is a bit pattern which contains information about the state of the Model 10000W1000A. The definitions of these bit positions can be found in the table below.

NOTE: Bits labeled NOT USED may be read as a bit state of 1 or 0

	BIT POSITION	BIT DESCRIPTION	BIT STATE		NOTES:
			0	1	
x	0	(NOT USED)			
	1	(NOT USED)			
	2	(NOT USED)			
	3	REMOTE CONTROL	DISABLED	ENABLED	Response to key-switch position
y	0	POWER STATUS	OFF	POWER ON	
	1	STANDBY STATUS	OFF	STANDBY	Also known as RF OFF
	2	OPERATE STATUS	OFF	OPERATE	Also known as RF ON
	3	FAULT STATUS	OFF	FAULT EXISTS	
z	0	KEYLOCK INHIBIT	OFF	INHIBITED	Response to key-switch position
	1	ALC ALERT	OK	FOLD BACK	ALC fold back indication
	2	(NOT USED)			
	3	(NOT USED)			
a	0	MODE MANUAL	DISABLED	ENABLED	Also known as CW MODE
	1	(NOT USED)			
	2	MODE ALC INTERNAL	DISABLED	ENABLED	
	3	(NOT USED)			

Example: To read the state, send the following query.

STATE?<LF>

Response: **STATE=<space>8301<LF>** (Remote Mode, Power On, RF OFF, and Manual Mode)

2.5.2.6.10 Forward Power

Query to get the forward power.

Max time to execute: 10mS

Syntax: **FPOW?**

Parameters: None

Response Format: **FPOW=x<LF>**

Where:

x = 0 to 99999

Values are corrected and linearized. They can be up to five digits in length. Leading zeros are read as spaces. Units are Watts.

Example: To find out the forward power, send the following query.

FPOW?<LF>

Response: **FPOW=<space><space><space>54<LF>** (54 Watts of forward power)

2.5.2.6.11 Reverse Power

Query to get the reverse power.

Max time to execute: 10mS

Syntax: **RPOW?**

Parameters: None

Response Format: **RPOW=x<LF>**

Where:

x = 0 to 99999

Values are corrected and linearized. They can be up to five digits in length. Leading zeros are read as spaces. Units are Watts.

Example: To find out the reverse power, send the following query.

RPOW?<LF>

Response: **RPOW=<space><space><space><space>9<LF>** (9 Watts of reverse power)

2.5.2.6.12 RF Gain

Query to get the RF gain.

Max time to execute: 10mS

Syntax: **RFG?**

Parameters: None

Response Format: **RFG=<space>x<LF>**

Where:

x = 0000 to 0100

Example: To find out the RF gain of the Model 10000W1000A, send the following query:

RFG?<LF>

Response: **RFG=<space>0075<LF>** (75% Gain)

2.5.2.6.13 Faults

Query to find the faults that have occurred with the Model 10000W1000A.

Max time to execute: 10mS

Syntax: **FSTA?**

Parameters: None

Response Format: **FSTA=<space>xxxx<LF>**

Where:
xxxx = 0000 to 0427 (Hexadecimal)

Dec	xxxx	Fault Text	Description	RF State After Fault Reset
0	0000	N/A	No Fault	N/A
1	0001	AC Interlock	AC Interlock	Off
2	0002	Interlock	Interlock	Off
3	0003	PS1	Driver Power Supply 1	Off
4	0004	PS2	Driver Power Supply 2	Off
5	0005	PS3	Driver Power Supply 3	Off
11	000B	Amp A18	Driver Amplifier Module A18	On
12	000C	Amp A17	Driver Amplifier Module A17	On
13	000D	Amp A16	Driver Amplifier Module A16	On
14	000E	Amp A15	Driver Amplifier Module A15	On
15	000F	Amp A14	Driver Amplifier Module A14	On
16	0010	Amp A13	Driver Amplifier Module A13	On
17	0011	Amp A12	Driver Amplifier Module A12	On
18	0012	Amp A11	Driver Amplifier Module A11	On
19	0013	Amp A10	Driver Amplifier Module A10	On
20	0014	Amp A9	Driver Amplifier Module A9	On
21	0015	Amp A8	Driver Amplifier Module A8	On
22	0016	Amp A7	Driver Amplifier Module A7	On
23	0017	Amp A2	Driver Amplifier Module A2	On
25	0019	485 Error	Internal RS-485 Communication Bus Error	Off
26	001A	ALC	ALC at max attenuation but output still over limit	Off
70	0046	System Error (A or B)	Fiber-Optic or Piggyback Communication Bus Error	Off
77	004D	PS2 Thermal	Power Supply 2 Over Temperature	Off
78	004E	PS3 Thermal	Power Supply 3 Over Temperature	Off
84	0054	Thermal A18	Driver Module A18 Over Temperature	Off
85	0055	Thermal A17	Driver Module A17 Over Temperature	Off
86	0056	Thermal A16	Driver Module A16 Over Temperature	Off
87	0057	Thermal A15	Driver Module A15 Over Temperature	Off
88	0058	Thermal A14	Driver Module A14 Over Temperature	Off
89	0059	Thermal A13	Driver Module A13 Over Temperature	Off
90	005A	Thermal A12	Driver Module A12 Over Temperature	Off
91	005B	Thermal A11	Driver Module A11 Over Temperature	Off
92	005C	Thermal A10	Driver Module A10 Over Temperature	Off
93	005D	Thermal A9	Driver Module A9 Over Temperature	Off
94	005E	Thermal A8	Driver Module A8 Over Temperature	Off
95	005F	Thermal A7	Driver Module A7 Over Temperature	Off
96	0060	Thermal A2	Driver Module A2 Over Temperature	Off

Driver/System

The fault tables for MPA's/block's (1 through 24) are identical, however they are offset by a value of 40 decimal (0028 hexadecimal). The following table is for MPA1/B1. MPA2/B2 for example, would have the same faults but starting at 163 decimal (00A3 hexadecimal).

Dec	xxxx	Fault Text	Description	RF State After Fault Reset
123	007B	B1 PS2	B1 Power Supply 2	Off
124	007C	B1 PS1	B1 Power Supply 1	Off
128	0080	B1 Thermal A14	B1 Module A14 Thermal	Off
129	0081	B1 Thermal A13	B1 Module A13 Thermal	Off
130	0082	B1 Thermal A12	B1 Module A12 Thermal	Off
131	0083	B1 Thermal A11	B1 Module A11 Thermal	Off
132	0084	B1 Thermal A10	B1 Module A10 Thermal	Off
133	0085	B1 Thermal A9	B1 Module A9 Thermal	Off
134	0086	B1 Thermal A8	B1 Module A8 Thermal	Off
135	0087	B1 Thermal A7	B1 Module A7 Thermal	Off
136	0088	B1 Amp A14	B1 Module A14 Amp Fault	On
137	0089	B1 Amp A13	B1 Module A13 Amp Fault	On
138	008A	B1 Amp A12	B1 Module A12 Amp Fault	On
139	008B	B1 Amp A11	B1 Module A11 Amp Fault	On
140	008C	B1 Amp A10	B1 Module A10 Amp Fault	On
141	008D	B1 Amp A9	B1 Module A9 Amp Fault	On
142	008E	B1 Amp A8	B1 Module A8 Amp Fault	On
143	008F	B1 Amp A7	B1 Module A7 Amp Fault	On

MPA1/B1

Example: To find out what faults have occurred, send the following query. **FSTA?<LF>**

Response: **FSTA=<space>0002<LF>** (*Interlock Fault*)

2.5.2.6.14 Operating Hours (RF On)

Query to get the RF On operating hours.

Max time to execute: 10mS

Syntax: **OH?**

Parameters: None

Response Format: **OH=x<LF>**

Where:

x = 0 to 100000

Units are Hours. Values can be up to six digits in length. Leading zeros are read as spaces.

Example: To find out the RF On operating hours, send the following query.

OH?<LF>

Response: **OH=<space><space><space><space>37<LF>**
(The system has spent 37 Hours in an RF On state)

2.2.2.6.15 Operating Hours (Power On)

Query to get the Power On operating hours.

Max time to execute: 10mS

Syntax: **OHP?**

Parameters: None

Response Format: **OHP=x<LF>**

Where:

x = 0 to 100000

Units are Hours. Values can be up to six digits in length. Leading zeros are read as spaces.

Example: To find out the Power On operating hours, send the following query.

OHP?<LF>

Response: **OHP=<space><space><space>428<LF>**
(The system has spent 428 Hours in a Power On state)

2.5.2.6.16 Remote Operating Timeout

Command to set the period between required communications to maintain an RF On state while in remote mode.

Max time to execute: 10mS

Syntax: **ROPTOx**

Parameters: x = 0 to 500 in seconds

Query: **ROPTO?**

Response Format: **ROPTO=x<LF>**

Example: To set the required period between communications that must be maintained once RF On has been initiated, send the following command.

ROPTO10<LF>

To find out what the period between communications that must be maintained once RF On has been initiated, send the following query.

ROPTO?<LF>

Response: **ROPTO=6<LF>**

2.5.2.6.17 ALC Board Firmware Revision

Query to get the firmware revision of the ALC board assembly.

Max time to execute: 10mS

Syntax: *ALC?

Parameters: None
Query only (always requires a ? character)

Response Format: ALC_SW_REVx<LF>

Where:

x = firmware revision

Example: To get the firmware rev. of the ALC board assembly, send the following command:

*ALC?<LF>

Response: ALC_SW_REV1.60<LF>

2.5.2.6.18 SBB (Piggyback) Firmware Revision

Query to get the firmware revision of the piggyback SBB assembly.

Max time to execute: 10mS

Syntax: *SBB?

Parameters: None
Query only (always requires a ? character)

Response Format: SBB_SW_REVx<LF>

Where:

x = firmware revision

Example: To get the firmware rev. of the piggyback SBB assembly, send the following command:

*SBB?<LF>

Response: SBB_SW_REV2.40<LF>

2.5.2.6.19 SBB (Optical) Firmware Revision

Query to get the firmware revisions (groups of twenty) of the SBB assemblies that are fiber-optically connected to the MPB assembly.

Max time to execute: 25mS

Syntax: ***SBBn?**

Parameters: n = group number (1 or 2)
Query only (always requires a ? character)

Response Format: **SBB_SW_REVx<LF>**

Where:

x = firmware revision

Example: To get the firmware revisions of the first twenty (20) SBB assemblies, send the following command:

***SBB1?<LF>**

Response: **SBB_SW_REV2.50,2.50,2.50,2.50,2.50,2.50,2.50,2.50,2.50,2.50,2.50,2.50,2.50,2.50,2.50,2.50,2.50,2.50,2.50,2.50<LF>**

2.5.2.6.20 System Serial Number

Query to get the serial number of the system.

Max time to execute: 10mS

Syntax: **SN?**

Parameters: None
Query only (always requires a ? character)

Response Format: **x<LF>**

Where:

x = serial number (6 to 8 characters)

Example: To get the serial number, send the following command:

SN?<LF>

Response: **1234567<LF>**

2.5.2.6.21 AC Power-On Defaults

Default settings that are applied at AC mains power-on can be changed by adding the following prefix to select commands.

Syntax: **DEFAULT:**

Compatible commands:

Level Adjust

LEVEL:GAIN	
LEVEL:DET	(Not available on all models)
LEVEL:THR	(Not available on all models)
LEVEL:RESP	(Not available on all models)

Mode Select

MODE:MANUAL	(Not available on all models)
MODE:PULSE	(Not available on all models)
MODE:ALC<space>INT	(Not available on all models)
MODE:ALC<space>EXT	(Not available on all models)

NOTES:

1. Use the command **DEFAULT:FACTORY** to reset all applicable settings back to their factory defaults.
2. All applicable defaults can be queried, except **DEFAULT:FACTORY**, by adding a ? character in place of the setting parameter.
3. If the ALC Lockout Feature (not available on all models) is engaged, the default ALC values set with this command will not be used.

Example 1: To set the default RF Gain to 75%, send the following command:

DEFAULT:LEVEL:GAIN75<LF>

Example 2: To query the default RF Gain setting, send the following command:

DEFAULT:LEVEL:GAIN?<LF>

Response: **DEFAULT:LEVEL:GAIN75<LF>**

Example 3: To set the default mode to manual, send the following command:

DEFAULT:MODE:MANUAL<LF>

2.5.2.7 Interlocks

The Model 10000W1000A has two separate interlock circuits that are wired to the rear panel Safety Interlock connector. Both interlocks require normally closed external circuits to allow the amplifier to function.

2.5.2.7.1 Inhibit Interlock

For interlock applications where the amplifier is not required to shut down completely (AC Off), this interlock circuit inhibits RF amplification by disabling the low-level amplifier stages and forcing the amplifier into the Standby (RF OFF) condition.

The Inhibit Interlock is wired to the rear panel interlock connector pins 1 and 8. A closed circuit from interlock connector pin 1 to pin 8 is required for normal operation. Opening the Inhibit Interlock connection will inhibit the amplifier and display **Interlock** on the front panel.

When the Inhibit Interlock circuit is restored to a closed condition, the Inhibit Interlock fault can be cleared by pressing the **RESET** button on the touch screen or by using the RESET remote command (when the Keylock Switch is set to **REMOTE**). After the Inhibit Interlock fault is cleared, the RF ON command must be re-asserted to return to an RF ON condition.

2.5.2.7.2 AC Interlock

For interlock applications that are more safety critical, where logic circuits are not trusted, the AC Interlock can be used to disconnect the major amplifier circuits from the AC mains.

The AC Interlock is wired to the rear panel interlock connector pins 10 and 14. This interlock circuit is connected directly in series with the AC relay circuit. There are no logic circuits or transistors in this signal path. A closed circuit from interlock connector pin 10 to pin 14 is required for normal operation. Opening the AC Interlock connection will disconnect AC primary power to all MPAs/Blocks and display **AC Interlock** on the front panel.

When the AC Interlock circuit is restored to a closed condition, the AC Interlock fault can be cleared by pressing the **RESET** button on the touch screen or by using the RESET remote command (when the Keylock Switch is set to **REMOTE**). After the AC Interlock fault is cleared, the RF ON command must be re-asserted to return to an RF ON condition.

2.6 RF OUTPUT

The output of the Model 10000W1000A is provided through a 4-1/16" EIA RF connector located on the top rear of the controller rack.



CAUTION:

Do not connect or disconnect any loads or cables from the amplifier's RF Output when the amplifier is in the Operate mode. Dangerous voltages that could cause serious injury to the user exist at the RF Output when the amplifier is under power.

2.7 ELECTRICAL POWER

There is one power connection for the Model 10000W1000A. This connection requires a 480VAC 3-phase delta connection, 47-63 Hz, 48,000 watts.

3. THEORY OF OPERATION

3.1 INTRODUCTION

The Model 10000W1000A consists of a driver amplifier assembly, twenty-four 500 watt module blocks, twelve 16-way combiners, a 12-way combiner and a directional coupler. The driver amplifier amplifies low level RF signals and provides RF signals that are matched in amplitude and phase to the 500 watt module blocks.

The twenty-four 500 watt module blocks provide a total of 192 output signals combined in the final 16-way combiners and the 12-way combiner, yielding a combined power of 10000 watts or more. The driver amplifier provides power and operate signals to each 500 watt module block and also monitors the 500 watt module blocks for any fault indications.

3.2 RF AMPLIFIER OPERATION (DRIVER/CONTROLLER AMPLIFIER, SCHEMATIC 10044325)

3.2.1 A1 Variable Gain Amplifier (Block Diagram 10034229)

The A1 variable gain amplifier consists of 3 subassemblies: the A1 Pre-Amplifier PWB Assembly, the A2 High Isolation Switch Assembly, and the A3 Two-Watt Amplifier Assembly.

3.2.1.1 A1 Pre-Amplifier PWB Assembly (Schematic 10033908)

The Pre-Amplifier PWB Assembly consists of a stage of gain (U1), a variable attenuator (U2), a resistive splitter (R3, R5, R4), another stage of gain (U3) an RF power detector (U9) and control circuitry. The overall gain of the pre-amplifier assembly is approximately 17 dB at minimum attenuation. The power detector (U9) is used to sense the input RF power and it increases the attenuation of U2 if an input overdrive condition is detected.

3.2.1.2 A2 High Isolation Switch (Schematic 10031969)

The High Isolation switch is normally in the thru mode. The switch can reduce the amplifier gain by more than 40 dB when the pulse input (E4) is pulled low.

3.2.1.3 A3 Two-Watt Amplifier (Schematic 10032110)

The Two-Watt Amplifier has a gain of approximately 16 to 18 dB. The Two-Watt Amplifier increases the overall variable gain amplifier to approximately 31 to 32 dB of gain. The output RF power is approximately 30 dBm at the 1 dB compression point.

3.2.2 A3, A4, A5 Four-Way Splitter

The Four-Way splitter splits the input signal into four equal-amplitude, equal-phase signals. The amplitude of each signal is 6–6.5 dB below the input signal when both outputs are terminated into 50Ω loads.

3.2.2 A19 Thru A30 Two-Way Splitter

The Two-Way splitter splits the input signal into two equal-amplitude, equal-phase signals. The amplitude of each signal is 3–3.5 dB below the input signal when both outputs are terminated into 50Ω loads.

3.2.3 A2, A7 thru A18 Driver Amplifiers (Schematic 10045386)

The A2, A7-A18 Driver amplifiers consist of RF matching circuits, RF transistors, DC current control circuits, DC switching circuits and fault detection circuits.

The RF input is fed to a 4:1 transformer composed of T1, T2, and T3. The push-pull output signal of the 4:1 transformer is connected to the gates of push-pull connected Q1. The drains of Q1 are connected to a 4:1 transformer composed of T4, T4 and T6. The RF transistor, Q1, has approximately 22.5 VDC applied to the drains at 4 amps current for the driver and 7 amps current for the finals. The RF stage has approximately 18 dB of gain for the finals and an output compression point of 50 watts or greater.

Voltage comparator U1 senses the presence of the -8 VDC. The output of U1 is high if the -8V supply is -5.5 or less. The output of U1 pulls low when the -8 volts is present turning on Mosfet Q2 which supplies the DC voltages to the drain of Q1.

The current through Q1 is monitored by U2. The output of U2 is fed to an op amp (U5) which has a reference voltage on the non-inverting input and it compares the output of U2 to the reference voltage and generates an error signal to vary the gate voltage of the RF transistor Q1 which controls the drain current.

U3 is a positive 5V regulator. It supplies DC to the current sense circuit, U2, the op amp, U5, and the fault detection circuit, U6. SW1 is a thermal switch. It closes at a heat sink temperature of approximately 70° to protect the module in the event of an over-temperature condition.

3.2.4 A32 Dual Detector Assembly (Schematic 10033688)

The Dual Detector monitors the outputs from the A19 dual directional coupler. The dual detector provides sample outputs of the forward and reverse powers and also DC outputs proportional to the forward and reverse powers of the amplifier.

There are two identical channels in the dual detector; only the one J1 input is described. The input from J1 is connected to a two-way splitter. The two-way splitter outputs go to a 6 dB attenuator (U3) and the RF input of the power detector (U2). The power detector provides a DC output which provides a signal to display output power and for amplifier protection. The output of attenuator (U3) is fed to a stage of gain (U4) which is connected to a 3 dB attenuator (U5). The output from U5 provides an RF sample output which can be used to monitor the amplifier output power. The gain from J1 to J2 is approximately 1.0 to 1.5 dB of gain.

3.2.5 Power Supplies, Driver Amplifier (PS1, PS2 AND PS3)

Power supply PS1 supplies a +5VDC housekeeping supply for the control system assemblies A1 Control Panel Assembly and A31 ALC board.

PS1 also supplies +24 VDC at 10 amps, +12 VDC at 13 amps, -12 VDC at 5 amps. PS1 is a switching supply that automatically sets the AC input circuits to the correct connections for the line voltage 90-264 VAC input ranges 47-440 Hz.

The +24 VDC at 10.0 amp power supply is fed to the A1 Pre-Amplifier to supply the FET drain voltage for this amplifier. The +12 VDC at 13 amps is for fans B1 through B7.

The -12 V at 5 amps power supply is fed to the A1 Pre-Amplifier, A2 W-Module and Driver modules A7 thru A18 to provide gate voltage for these modules.

PS2 and PS3 supplies +24 VDC at 44 amps. PS2 and PS3 are switching power supplies that automatically sets the AC input circuits to the correct connections for the line voltage 120-240 VAC, 50-60 Hz.

PS2 supplies +24 VDC to modules A7-A12 to provide the drain voltage for these amplifiers.

PS2 supplies +24 VDC to modules A13-A18 to provide the drain voltage for these amplifiers.

3.3 RF AMPLIFIER OPERATION: 500 WATT MODULE BLOCKS A2-A24 (500 WATT POWER AMPLIFIER SCHEMATIC, 10045661)

3.3.1 A4 Two-Way Splitter

The Two-Way splitter splits the input signal into two equal-amplitude, equal-phase signals. The amplitude of each signal is 3–3.5 dB below the input signal when both outputs are terminated into 50Ω loads.

3.3.2 A5, A6 Four-Way Splitters

Each Four-Way splitter splits the input signal into four equal-amplitude, equal-phase signals. The amplitude of each signal is 6–6.5dB below the input signal when both outputs are terminated into 50Ω loads.

3.3.3 A7-A14 Final Amplifiers (Schematic 10036697)

Each A7-A14 Final Amp consists of RF matching circuits, an RF transistor a DC current control circuit, a DC switching circuit and a fault detection circuit.

The RF input is fed to a 4:1 transformer composed of T1, T2, and T3. The push-pull output signal of the 4:1 transformer is connected to the gates of push-pull connected Q1. The drains of Q1 are connected to a 4:1 transformer composed of T4, T4 and T6. The RF transistor, Q1, has approximately 22.5 VDC applied to the drains at 4 amps current for the driver and 7 amps current for the finals. The RF stage has approximately 18 dB of gain for the finals and an output compression point of 50 watts or greater from final amplifiers A7-A14.

Voltage comparator U1 senses the presence of the –8 VDC. The output of U1 is high if the –8V supply is –5.5 or less. The output of U1 pulls low when the –8 volts is present turning on Mosfet Q2 which supplies the DC voltages to the drain of Q1.

The current through Q1 is monitored by U2. The output of U2 is fed to an op amp (U5) which has a reference voltage on the non-inverting input and it compares the output of U2 to the reference voltage and generates an error signal to vary the gate voltage of the RF transistor Q1 which controls the drain current.

U3 is a positive 5V regulator. It supplies DC to the current sense circuit, U2, the op amp, U5, and the fault detection circuit, U6. SW1 is a thermal switch. It closes at a heat sink temperature of approximately 70° to protect the module in the event of an over-temperature condition.

3.3.4 Power Supplies, 500 Watt Module Blocks (PS1 and PS2)

Power supply PS2 supplies a +5VDC housekeeping supply for the control system assemblies A1 Switch Breakout Assembly and A3 Fiber Optic interface for the system control.

PS2 also supplies +24 VDC at 10 amps, +12 VDC at 13 amps, -12 VDC at 5 amps. PS2 is a switching supply that automatically sets the AC input circuits to the correct connections for the line voltage 90-264 VAC input ranges 47-440 Hz.

The +24 VDC at 10.0 amp power supply is fed to the fans B1 and B2. The +12 VDC is fed to the A3 overdrive sense board.

The -12 V at 5 amps power supply is fed to the A7-A14 final modules to provide gate voltage for these modules.

PS1 supplies +24 VDC at 60 amps. PS1 is a switching power supply that automatically sets the AC input circuits to the correct connections for the line voltage 120-240 VAC, 50-60 Hz.

PS1 supplies +24 VDC to amplifiers A7-A14 to provide the drain voltage for these amplifiers.

3.4 A26-A37 SIXTEEN-WAY COMBINERS

The 16-way combiner has impedance-matching. When the outputs of the 16 final amplifiers are fed to the sixteen 16-way combiners, the combined output will be approximately 12 dB above the output of a single final amplifier.

3.5 A38 12-WAY COMBINER/BIDIRECTIONAL COUPLER

The twelve outputs from the twelve 16-Way combiners are combined into one output in the 12-way output combiner. The combiner is designed to tolerate loss of input signals at full output power. The single output then passes through a bidirectional coupler (internal to the combiner). The forward and reflected ports of the directional coupler are at a level of about -71 dB relative to the main output signal. The RF detectors for converting the amplifier's Forward and Reflected RF signals to usable DC signals are located in the driver/control unit. The detected signals are used by the ALC, fault detection/control circuits and by the Forward and Reflected power display on the Digital Control Panel (DCP).

3.6 POWER DISTRIBUTION

Main power to the unit is supplied by 2 three-phase Power Distribution Units designed for a five-wire, three-phase Wye connection: the five wires are for the three phases and a safety ground (GND) (Neutral wire not required). The primary input voltage range is 360-435 VAC phase-to-phase. A 100-amp common trip circuit breaker located on both power units is used to supply power to The Model 10000W1000A.

The driver/control units and the 500-watt module blocks, are fed from outlets in these power distribution units. The Driver/control unit and the 500 watt module blocks all have internal AC relays. The relays are controlled by the front panel Power ON/Off switch and interrupted manually by the three-position key-switch labeled INHIBIT - LOCAL - REMOTE. The relays feed AC directly to the primary inputs of the main power supplies. When the main circuit breaker is on, AC power is fed to the low level/bias supply PS1 in the driver/control unit. Therefore, when the circuit breaker is turned on, the control panel and basic low-power supplies are alive, and the amplifier is armed for Power On. At this time, the front panel display is illuminated and the control circuitry is active.

3.7 CONTROL SYSTEM

3.7.1 Fiber-Optic System Control Link

The 1000W1000 control system uses a fiber-optic communication system to link each of the 500 watt module Blocks back to the Driver/Controller unit. The Digital Control Panel (DCP) uses this link to send information to the system 500 watt module Blocks and read fault conditions. Therefore this link is critical to the operation of the amplifier system. When the system is powered up, the DCP goes through an addressing process in which a communication link is established for each item in the serial chain. If this process fails, a fault condition is generated.

An LED is installed on the rear of each 500 watt module Block to indicate the state of this link. See Table 3-1 below for the link states. This information is also indicated on a label next to the LED.

Table 3-1. Link States

LED	F/O LINK
OFF	NONE
BLINK	LOCAL
ON	SYSTEM

If the LED is off, then either there is no power to the 500 watt power amplifier or the internal Switch Breakout Board (SSB) assembly failed to initialize.

If the LED is blinking, it means that locally the 500 watt power amplifier is powered and the SBB is initialized.

If the LED is on solid, the communications link has been established with the DCP.

For the amplifier to be able to go to an RF on state, all 500 watt power amplifier link LED's must be on solid.

3.7.2 Power On/Operate Circuits

This section describes the functioning of the switches, relays and controls in the AC/DC power distribution system.

The following description assumes that all the power distribution breakers are closed, making AC power available to the amplifier components. In the Model 10000W1000A DCU, +5VDC from PS1 is connected to the digital control panel and the ALC board whenever CB1 on the DCU rear panel is closed.

Relay K1 in the DCU controls AC power to the main power supplies in the DCU and the 500 watt module block assemblies for amplifier operation. K1 applies power to the main power supply PS2 in the DCU. K1 controls the AC relays in the 500 watt module blocks, which applies AC power to PS1, the main power supply to the 500 watt amplifier modules. Control for relay K1 loops through the 9 pin Sub-D monitor interlock connectors connected to each 500 watt module block to the driver amplifier assembly. Note that in order to complete the circuit through K1, the external AC interlock circuit must be closed. The I/O panel Safety Interlock connector provides pins 10 and 14 for this purpose. Another interlock circuit, provided in the same connector, is used for RF inhibit, pins 1 and 8, if the user so desires. Both types can be used simultaneously in their respective circuits. If the AC interlock circuit is open, a direct logic signal will be applied to the control panel to display **AC Interlock** on the display when Power On is attempted. If the Inhibit interlock is open, **Interlock** will be displayed.

If the Keylock Switch is in the REMOTE position, the Power and Operate functions are the same except that they can only be performed remotely (i.e., from the user's computer), since the front panel controls are locked out when the amplifier is in the Remote mode.

3.7.3 Automatic Level Control Circuits

This section describes the operation of the Automatic Level Control (ALC) circuit board. Refer to schematic diagram number 10023927, **Schematic, Digital ALC Board**.

The ALC board performs the following general functions:

- It limits the RF drive level to the amplifier stages when the amplifier's Forward or Reflected power levels try to exceed preset levels.
- It sends a fault signal to the Digital Control Panel (DCP) if the limiting previously described fails to control the amplifier's Forward or Reflected power levels. This fault signal ultimately inhibits the amplifier.
- Allows the user the means to level at a set output power level.

3.8 FAULT DETECTION CIRCUITS

This section describes the function and theory of the Model 10000W1000A's fault detection circuits.

Faults from the 500 watt module Blocks are transmitted to the DCP by the Switch Breakout Board (SBB), A1 in the 500 watt module Block. The SBB assembly processes fault information from all eight RF amplifier modules within the 500 watt module Block. The faulty module location is displayed, and a red LED indicator lights on the module at fault. Note that after a fault condition has been invoked, the circuit breaker and DCU circuit breakers must be left on to keep the temporary memory active, until all faults can be manually recorded for diagnostic purposes. Faults may be recorded by the host system if the host software is written to respond to fault conditions. Fault conditions may be queried at any time during normal operation of the Model 10000W1000A.

Detected fault signals are recorded in temporary (volatile) memory before the amplifier control circuits act to protect the amplifier, sometimes resulting in RF inhibit or shut down. In some cases, inputs are read multiple times to prevent a transient signal from causing an unwarranted action. Note that after a fault condition has been invoked, the circuit breaker CB1 must be left on to keep the temporary memory active, so that all faults can be manually recorded for diagnostic purposes. Faults may be recorded by the host system if the host software is written to respond to fault conditions. Fault conditions may be queried at any time during normal operation of the amplifier.

3.8.1 Thermal Faults

Each of the power modules contains thermal sensor switches. In the case of a thermal fault, the line will go low. The control panel displays the module designator and Thermal A#, and the main power supplies will be inhibited to allow the modules to cool down.

3.8.2 Amplifier Faults

Detailed theory of operation of the RF Power module is covered in Section 3.3.3. Parts dealing with faults are explained here.

Refer to schematic diagram 10036697, **W-Module**. There are two possible fault conditions that will signal the control system. They are if the module goes either over-current or under-current.

On each RF power module, a current-sensing IC delivers an output voltage which is proportional to the current being drawn. This voltage is compared to a reference voltage range by an op-amp. If the output voltage exceeds the reference voltage range, the op amp's output goes low to indicate that too much or too little current is being drawn. This causes the control panel to display the module designator location as an **AMP FAULT**, as well as inhibiting the Pre-amplifier driver stages.

3.8.3 Power Supply Faults

The main power supplies in the DCU and 500 watt module Blocks are monitored internally. If a supply fails to produce DC voltage within its specification, a logic signal will signal the fault board, resulting in an instant shut down. The power supply faults and inhibit signals are routed to the Control Panel.

3.8.4 ALC Fault

An ALC fault is invoked whenever the forward or reverse power limit controls do not function, causing the RF power to exceed one of the preset limits. The ALC fault is a logic low when invoked. The logic low from the ALC board signals the digital control panel, which, in turn, disables the RF output by inhibiting the main supply, PS1

3.8.5 Interlocks

The Model 10000W1000A Driver has two interlocks that are wired to the rear panel Safety Interlock connector. The interlocks are separate circuits. Both interlocks require normally closed external circuits to allow the amplifier to function.

3.8.5.1 Inhibit Interlock

For interlock applications where the amplifier is not required to shut down totally (AC Off), this interlock circuit inhibits RF amplification by disabling the preamp in the DCU and power supplies and forcing the amplifier into the Standby (RF Off) condition. The inhibit interlock is wired to the rear panel Interlock connector pins 1 and 8. A closed circuit from Interlock connector pin 1 to pin 8 is required for normal operation. Opening the connection will inhibit the Driver and display **Interlock** on the front panel. When the inhibit interlock has been opened, the Driver returns to the Standby (RF Off) condition, forcing the re-assertion of the Operate (RF On) command returns the unit to normal operation when the interlock fault condition has been removed and cleared.

3.8.5.2 AC Interlock

For interlock applications where it is desired to disconnect the AC power source from the main power supplies, the AC interlock can be used to disconnect the amplifier from the AC mains. This interlock circuit is connected directly in series with the relay coil K1 in the DCU, which actuate the relays for the main power supplies in the 500 watt module Blocks. Rear panel Interlock connector Pins 10 and 14 are for this purpose. Pin 10 provides the activation signal from the control panel P2-2 to the relay coils. Opening the AC interlock connection will disconnect AC primary power to all major circuits and display **AC Interlock** on the front panel.

Fault conditions can be reset by pressing the **RESET** button displayed on the Touch Screen located on the front panel or by sending the RESET remote command from the user's computer (when the Keylock Switch is set to **REMOTE**). Either of these conditions causes the Model 10000W1000A's DCU to return to normal conditions. Forcing the user to reassert the Operate command (RF On) after a fault or interlock condition is a safety feature that prevents an unexpected burst of RF when the fault or interlock condition has been restored. Fault conditions that require a 500 watt module Blocks to be disconnected from the AC mains will be reset automatically upon re-energizing the amplifier. Only fault conditions that continue to be valid will be displayed after the AC mains have been disconnect via the circuit breaker or external disconnection.

3.8.6 System Error (F/O Link Fault)

The fiber-optic serial link must be established before the amplifier system can go to an RF On state. This link is established immediately upon power on of the driver box. It is for this reason that all sub-amplifier breakers must be powered on before the driver rack is powered on. If the link fails to be established with all 500 watt amplifier assemblies, a fault condition is generated. The LED's on the rear of each 500 watt module Blocks can be used to determine where the link is broken.

4. TROUBLESHOOTING AND REPAIR

4.1 GENERAL

Because it is a relatively simple instrument, the Model 10000W1000A should require very little maintenance. It is built with solid state devices and printed wiring boards (PWBs) that should ensure long, trouble-free life. Should trouble occur, special care must be taken when servicing the unit to avoid damaging the solid state devices and PWB's.

Since the amplifier's components are soldered in place, substitution of components should not be resorted to unless there is some indication that they are faulty. In addition, care must be taken not to short voltages across the amplifier when troubleshooting, because small bias changes may damage the amplifier due to excessive dissipation or transients.

Components used in AR RF/Microwave Instrumentation instruments are conservatively operated to provide maximum instrument reliability. In spite of this, parts may fail. Usually, the instrument must be immediately repaired with a minimum of down time. A systematic approach can greatly simplify and thereby speed up repairs. The Model 10000W1000A incorporates fault control and detection circuits, including display panel indications that can expedite troubleshooting of the unit. For a description of how these indications can be used to assist in troubleshooting the unit, please see Section 4.3, **Fault Signal Interpretation and Diagnosis**.

Shipping instructions are as follows. To return an item, contact AR Customer Service for an RMA number and shipping instructions. Returns from outside the United States are not permitted without prior authorization. If shipping from outside of the United States, closely follow all directions on the RMA form for return shipping and marking. See warranty statement at rear of manual.

4.2 FAULT SIGNAL INTERPRETATION AND DIAGNOSIS

CAUTION:



Extreme caution should be exercised when troubleshooting this unit, particularly when measuring voltages in the power supply section, as hazardous voltages exist in the unit that could cause serious injury to personnel performing such measurements.

4.2.1 Indicators For Troubleshooting

The Model 10000W1000A controller is equipped with Fault Detection circuits to assist in troubleshooting. The Model 10000W1000A controller monitors each of the 500 watt module blocks and will report faults that occur with the modules and power supplies within each block.

4.2.2 General - Reading Faults

The Model 10000W1000A incorporates relatively simple fault detection circuitry, which makes use of the digital display panel to alert the user or technician which component(s) need service. Use of these indications can usually expedite troubleshooting of the amplifier. Most faults can be immediately determined down to the assembly level. If a reset is still indicated, turn off the RF power signal to the input of the amplifier, read and record the fault indication displayed on the digital control panel for later reference. Then, use the RESET function to see if the fault clears. If the fault clears, slowly bring the amplifier's drive level back up and ensure that recommended RF power levels are not exceeded. If the fault indication is no longer visible, the fault may have been brought about by a temporary transient condition, component thermal condition or excessive RF drive to the amplifier's input. If the fault does not clear with the RF drive off, some other problem exists in the amplifier.

4.2.3 Output Power Indicator

4.2.3.1 Controller Power Output Indicators

The Digital Control Panel of the Model 10000W1000A indicates the combined output power from the Model 10000W1000A and the Power Reflected back to it. If the Reflected Power is very high, with respect to the Forward Power, this could indicate that the output coax cable is defective or that the load being driven has a high VSWR.

4.2.4 Power Supply Faults

Indication – **PS(x)**

The 500 watt module Blocks and Driver Control Unit have self-contained power supplies. In the event of a power supply failure, the front panel display will identify which units power supply is at fault.

4.2.5 Thermal Faults

Indication – **Thermal A#**

Thermal faults usually indicate ambient temperature is too high, there is inadequate air-flow through the module heat sinks or there is a problem with the sensor in the module.

RF module thermal faults are detected. See Section 3.8.1. The heatsink temperature is monitored and will trigger a thermal fault if it overheats.

4.2.6 ALC Fault

Indication – **ALC**

As stated previously, the power limit controls could not limit either the forward or reverse power to the preset threshold. This can be a transient type of problem, if the fault can be cleared. If the fault cannot be cleared with no RF input drive power, then there is a malfunction in the ALC board or associated circuit.

4.2.7 Amplifier Faults

Indication – **AMP A#**

Any Amp fault will trigger amplifier RF shut down. Module faults are displayed as **AMP#** and indicates the defective module within the 500 watt module Blocks or driver amplifier.

Amplifier faults usually indicate there is a short circuit that would not clear on the module printed wiring board or component, or the module current limit is not adjusted correctly or one of the output devices is defective and/or not drawing enough current.

4.2.8 Fiber-Optic System Control Fault

If there is a point in the fiber-optic system control loop where one or more 500 watt module Blocks did not link properly, the source of the problem can be pin pointed by using the LED's found on the rear of each 500 watt amplifier. Starting at the driver/controller unit, the fiber-optic loop can be traced while paying attention to the LED state on each 500 watt module Block. The issue in the loop will be found just prior to wherever the first 500 watt module Block is found to have a blinking or off LED. Issues with the loop functionality can be caused by a damaged fiber-optic cable.

4.2.9 Fault Troubleshooting Guide

4.2.9.1 Model 10000W1000A Driver Amplifier Fault Troubleshooting Guide

Driver		
Fault	Type of Fault	Possible Reasons
485 driver	Communication	Disconnected or faulty W12 or W14 CAT5 cable.
Therm driver (A2, A7-A18)	Thermal	Driver fan blocked or clogged.
Amp Fault (A2, A7-A18)	Under Current, Over-Current	Driver FET is damaged and drawing no current, Gate voltage is being pulled down. Driver FET had been over driven. Usually resettable and cured by backing off input drive.
PS1, PS2, PS3	Power Supply	PS1,PS2 or PS3 has failed
ALC	Leveling	ALC circuit is not working and allowing the RF power to exceed a preset limit

4.2.9.2 Model 1000W1000A 500 watt Block Fault Troubleshooting Guide

500 Watt Power Amplifier B1-B24		
Fault	Type of Fault	Possible Reasons
Therm (B1-B24) (A7-A14)	Thermal	
Amp Fault (B1-B24) (A7-A14)	Under Current Over-Current	Final module FET is damaged and drawing no current, insufficient gate voltage to FET. Final module FET had been over driven. Usually resettable and cured by reducing input drive.
PS1 Final (B1-B12)	Power Supply	PS1 has failed inside MPA listed
PS2 Final (B1-B12)	Power Supply	PS2 has failed inside MPA listed

4.3 DIAGNOSING AND REPLACING AMPLIFIER MODULES

4.3.1 Locating Modules within the 10000W1000A

See Figure 4-1 and 4-2.

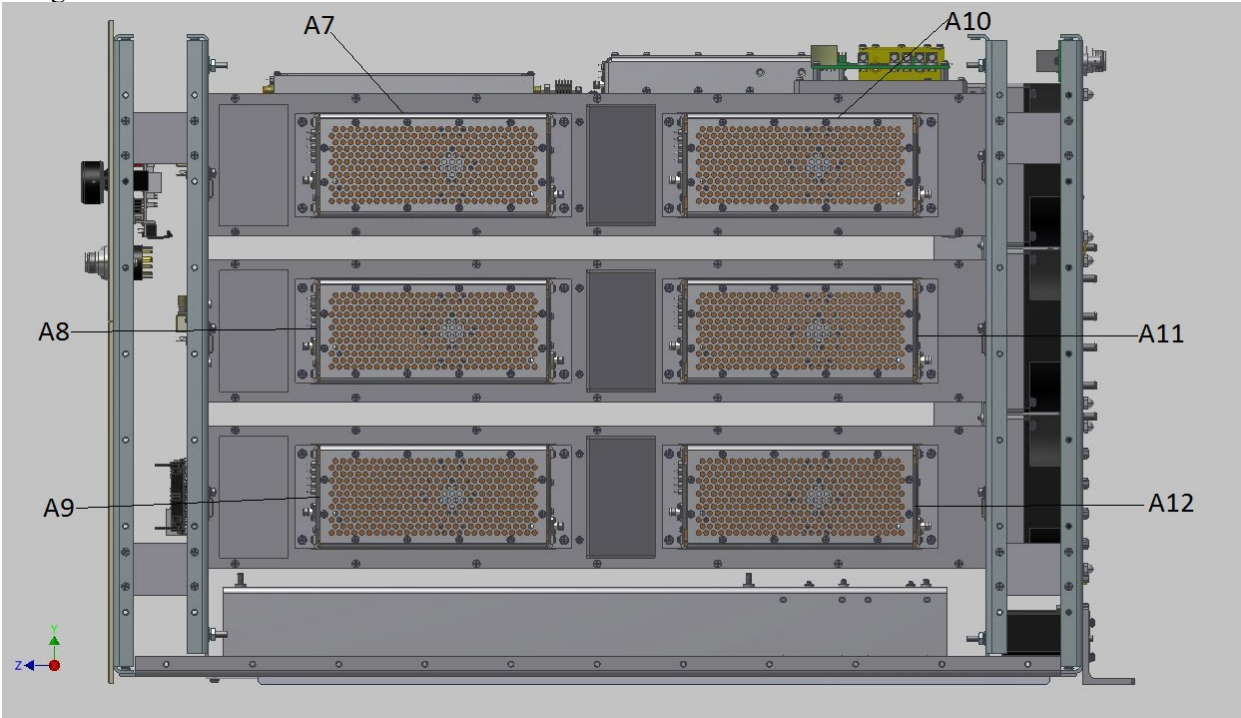

Figure 4-1. Driver Amp Module Locations (Right Side)

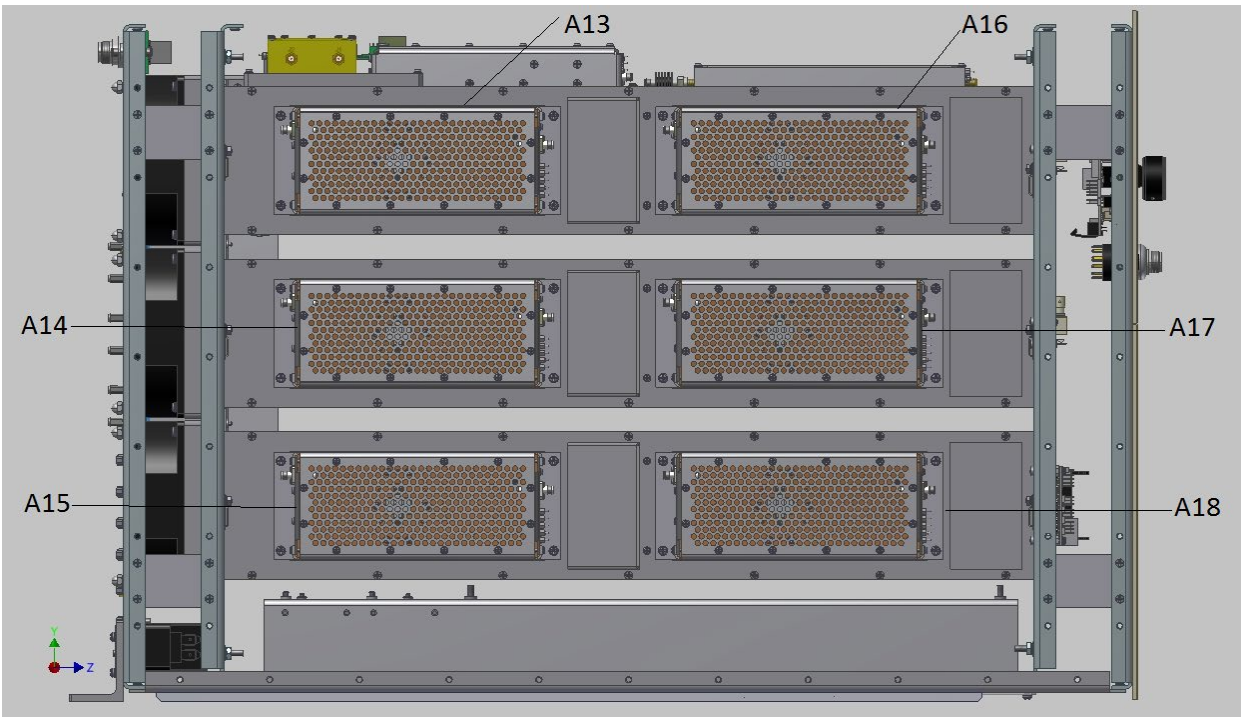

Figure 4-2. Driver Amp Module Locations (Left Side)

4.3.2 Locating Modules within the 1000W1000A 500 Watt Blocks

See Figures 4-3.

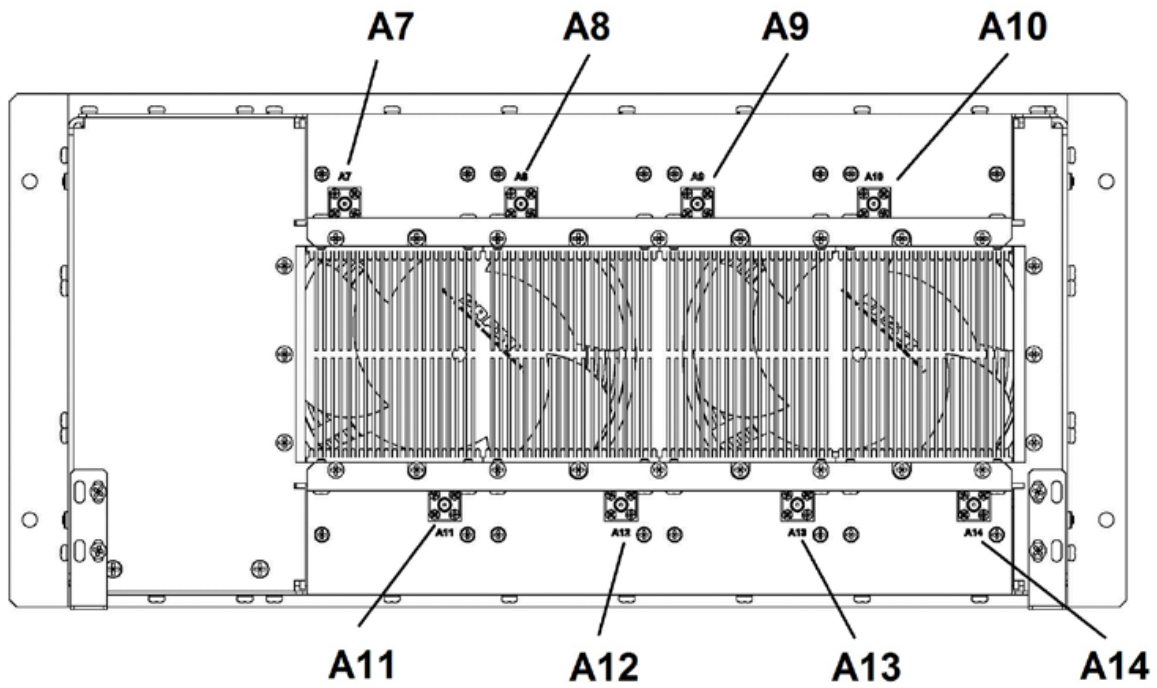

Figure 4-3. 500 Watt Module Blocks (B1-B24) Locations (Front View)

Appendix A. Installing Software Upgrades

A.1 FIRMWARE UPDATES

Most digital assemblies within the 10000W1000 control system can have their firmware updated by the end user. Some of these assemblies require hardware re-configuration while others do not. All firmware updates have some risk associated with them. It is for this reason that all firmware updates should be discussed with the AR Customer Service department before being performed.

All firmware updates will require a PC and a standard USB peripheral device cable (A-B connectors). It is recommended that the PC be 64-bit running Windows 7 or Windows 8 64-bit.

1. Download the AR Firmware Upgrade Utility from the AR website. There are two versions available for download. One version is for 32-bit operating systems and one version is for 64-bit operating systems. Select the appropriate version and download it to the PC that will be used to perform firmware updates.
2. Un-zip the Firmware Upgrade Utility file that was downloaded and run the installer executable. This will install the AR Firmware Upgrade Utility on the PC.

The following are assemblies that can be updated using the AR Firmware Upgrade Utility. Since updates for these assemblies are slightly different from one another each of their associated processes are listed separately. All of these updates can be performed in any order unless otherwise instructed by the AR Customer Service Department.

A.2 CONTROL - MULTI-PURPOSE BOARD ASSEMBLY FIRMWARE (X1)

1. Power off the entire Model 10000W1000A system.
2. Go to the AR website and download the firmware file for the Model 10000W1000A.
3. Once the download completes, unzip the firmware file on the PC that will be used to perform the firmware update. Do not change the names of the folder or files that are unzipped.
4. Run the AR Firmware Upgrade Utility and follow the instructions it provides.
5. Once the utility successfully connects to the Model 10000W1000A Driver Box, click the **Update** button for the Control firmware. The utility will step through an additional setup process similar to the one that was previously done. Follow these instructions exactly. When asked to power on the device, only power on the Driver Box.
6. When the utility confirms that the Model 10000W1000A is in the correct state, it will prompt for the model specific firmware file which was unzipped in the steps above. Select this file and allow the utility to complete the update process.
7. After the update is complete, cycle power to the entire Model 10000W1000A system.

A.3 I/O - INPUT OUTPUT BOARD ASSEMBLY FIRMWARE (X1)

1. Power off the entire Model 10000W1000A system.
2. Go to the AR website and download the IO firmware.
3. Once the download completes, unzip the firmware file on the PC that will be used to perform the firmware update. Do not change the names of the folder or files that are unzipped.
4. Run the AR Firmware Upgrade Utility and follow the instructions it provides. When asked to power on the device, only power on the Driver Box.
5. Once the utility successfully connects to the Model 10000W1000A0 Driver Box, click the Update button for the I/O firmware.
6. The utility will prompt for the IO firmware file which was unzipped in the steps above. Select this file and allow the utility to complete the update process.
7. After the update is complete, cycle power to the entire Model 10000W1000A system.

A.4 BREAKOUT - PIGGY-BACK CONNECTED SWITCH BREAKOUT BOARD (SBB) ASSEMBLY FIRMWARE (X1)

1. Power off the entire Model 10000W1000A system.
2. Go to the AR website and download the SBB firmware.
3. Once the download completes, unzip the firmware file on the PC that will be used to perform the firmware update. Do not change the names of the folder or files that are unzipped.
4. Run the AR Firmware Upgrade Utility and follow the instructions it provides. When asked to power on the device, only power on the Driver Box.
5. Once the utility successfully connects to the Model 10000W1000A Driver Box, double click the Model 10000W1000A model number in the upper right corner of the utility.
6. Enter the password 2157238181. This will uncover additional update options.
7. Click the Update button for the SBB Piggyback firmware.
8. The utility will prompt for the SBB firmware file which was unzipped in the steps above. Select this file and allow the utility to complete the update process.
9. After the update is complete, cycle power to the entire Model 10000W1000A system.

A.5 BREAKOUT - FIBER-OPTIC CONNECTED SWITCH BREAKOUT BOARD (SBB) ASSEMBLY FIRMWARE IN MPAS (X4)

1. Power off the entire Model 10000W1000A system.
2. Disconnect the TX and RX F/O SYS CONTROL connections from rear panel of the Driver Box.
3. Using a pair of fiber-optic cables, attach the TX and RX connections of the F/O SYS CONTROL found on the rear panel of the Driver Box, to the RX and TX connections on any MPA. (TX to RX and RX to TX).
4. Go to the AR website and download the SBB firmware.
5. Once the download completes, unzip the firmware file on the PC that will be used to perform the firmware update. Do not change the names of the folder or files that are unzipped.
6. Run the AR Firmware Upgrade Utility and follow the instructions it provides.
7. Once the utility successfully connects to the Model 10000W1000A, double click the Model 10000W1000A model number in the upper right corner of the utility.
8. Enter the password 2157238181. This will uncover additional update options.
9. Click the Update button for the SBB Optical firmware.
10. The utility will prompt for the SBB firmware file which was unzipped in the steps above. Select this file and allow the utility to complete the update process.
11. After the update is complete, power off the entire Model 10000W1000A system and restore all fiber-optic connections then power on the Model 10000W1000A.

A.6 AUTOMATIC LEVELING CONTROL (ALC) ASSEMBLY FIRMWARE (X1)

1. Power off the entire Model 10000W1000A system.
2. Go to the AR website and download the ALC firmware.
3. Once the download completes, unzip the firmware file on the PC that will be used to perform the firmware update. Do not change the names of the folder or files that are unzipped.
4. Run the AR Firmware Upgrade Utility and follow the instructions it provides. When asked to power on the device, only power on the Driver Box.
5. Once the utility successfully connects to the Model 10000W1000A Driver Box, double click the Model 10000W1000A model number in the upper right corner of the utility.
6. Enter the password 2157238181. This will uncover additional update options.
7. Click the Update button for the ALC firmware.
8. The utility will prompt for the ALC firmware file which was unzipped in the steps above. Select this file and allow the utility to complete the update process.

WARRANTIES: LIMITATION OF LIABILITY

Seller warrants (i) that seller has title to the goods sold and (ii) that Amplifiers (all parts excluding traveling wave and vacuum tubes), Antennas, field monitors, field probes, field analyzers, field analyzer processor units, system controllers, system interlock, power meters, leak detectors, RF conducted probes, RF conducted clamps, Multi-tone, EMI receiver systems, RF down converters, RF conducted immunity systems, conducted immunity accessories, radiated immunity test systems, safety meters, safety sensor heads, tripods, directional couplers, waveguide adapters, termination loads, load attenuators, impedance stabilization networks, and coaxial cables will be free from defects in material and workmanship for a period of three (3) years from date of shipment shown on AR RF/Microwave Instrumentation invoice.

All modules, used in the amplifiers for the 1-6 GHz, 4-18 GHz, 6-18 GHz, all HPM products, and other applications, are hermetically-sealed. This sealing process protects the internal hybrid circuitry from humidity that could compromise the long term reliability of the product. These modules are not field-repairable and should *never* be opened outside of AR's Microelectronics Lab. The modules in these product lines have a security label on two sides of the modules between the housing and lid/cover. If the security label is removed and or cut, the warranty of the module will be voided.

Vacuum tubes in the 'L' series amplifiers, traveling-wave tubes in TWT amplifiers, and power heads will be free from defects in material and workmanship for a period of one (1) year.

Contact AR RF/Microwave Instrumentation for warranty information regarding items not listed.

Seller's sole responsibility in fulfilling these warranties shall be to repair or replace any goods which do not conform to the foregoing warranties or, at seller's option, to give buyer credit for defective goods. The warranty is valid only when used in the country specified at time of order. Warranty service must be obtained from the repair facility designated at that time. If warranty service is not available in the country where the equipment is to be used, it must be returned to AR RF/Microwave Instrumentation. Warranty service will be provided only for defective goods which are returned within the warranty period, freight costs prepaid to AR RF/Microwave Instrumentation or its designated repair facility.

There are no other warranties, express or implied, including any warranty of merchantability or fitness. Seller shall not be responsible for any incidental or consequential damages arising from any breach of warranty.

No person other than an officer of Amplifier Research Corporation, has any authority to bind seller to any affirmation, representation or warranty except as specifically included in the preceding terms and conditions.

