



rf/microwave instrumentation

Operating and Service Manual

5000A225B

Model

10049488 (High Voltage)

10049506 (Low Voltage)

Part Number

Serial Number



rf/microwave instrumentation

Declaration of Conformity

Issue Date: October 2020
Model #/s: Model 5000A225B Series
Type of Equipment: RF Broadband Amplifier
Function: Designed to be used in a RF immunity test system or for research. The unit is intended to amplify an RF signal and inject it into a load.

The equipment described above is declared to be in conformity with the following applicable national and international standards. The conformity is valid only when equipment is used in a manner consistent with the manufacturer’s recommendations and the reference documents.

EMC:
DIRECTIVE 2014/30/EU of the European Parliament and of the Council of 26 February 2014 on the harmonisation of the laws of the Member States relating to electromagnetic compatibility
EN 61326-1:2013 Electrical equipment for measurement, control and laboratory use–EMC requirements–Part 1: General Requirements
SAFETY:
DIRECTIVE 2014/35/EU of the European Parliament and of the Council of 26 February 2014 on the harmonisation of the laws of the Member States relating to the making available on the market of electrical equipment designed for use within certain voltage limits
CENELEC EN 61010-1 Issued 2010/10/01 Ed: 3 Safety Requirements for Electrical Equipment for Measurement Control and Laboratory Use – Part 1: General Requirements
UL 61010-1 Issued 2012/05/11 Ed: 3 Safety Requirements for Electrical Equipment for Measurement Control and Laboratory Use – Part 1: General Requirements
CAN/CSA C22.2 #61010-1 Issued 2012/05/11 Ed: 3 Safety Requirements for Electrical Equipment for Measurement Control and Laboratory Use – Part 1: General Requirements
HAZARDOUS SUBSTANCES (RoHS):
DIRECTIVE 2011/65/EU of the European Parliament and of the Council of 8 June 2011 on the restriction of the use of certain hazardous substances in electrical and electronic equipment (recast) Commission Delegated Directive (EU) 2015/863 of 31 March 2015 amending Annex II to Directive 2011/65/EU of the European Parliament and of the Council as regards the list of restricted substances Directive (EU) 2017/2102 of the European Parliament and of the Council of 15 November 2017 amending Directive 2011/65/EU on the restriction of the use of certain hazardous substances in electrical and electronic equipment
RECYCLING (WEEE):
DIRECTIVE 2012/19/EU of the European Parliament and of the Council of 4 July 2012 on waste electrical and electronic equipment (WEEE) (recast)
SUBSTANCES OF VERY HIGH CONCERN (REACH):
REGULATION (EC) 1907/2006 of the European Parliament and of the Council of 18 December 2006 concerning the Registration, Evaluation, Authorization and Restriction of Substances of Very High Concern Chemicals (SVHC)

Supporting documentation is held by AR RF/Microwave Instrumentation’s Quality department in Pennsylvania, United States.

Place of issue: AR RF/Microwave Instrumentation
160 Schoolhouse Road
Souderton, Pennsylvania 18964 USA

Authorized officer of the company:

Patricia Thrasher
Manager Quality & Service

Instructions for European EMC Conformity



It is the responsibility of the user of this equipment to provide electromagnetic shielding, filtering and isolation which is necessary for EMC compliance to Directive 2014/30/EU. The equipment must therefore be operated in a shielded area which provides a sufficient level of attenuation to meet the radiated emissions and immunity specifications. The following minimum levels are suggested for use in accordance with the rated power of the equipment.

Rated Power	Minimum shielding attenuation
100 watts	50 dB
101 - 1000 watts	60 dB
1001 - 10,000 watts	70 dB

Since this equipment is designed to generate high levels of Radio Frequency energy, it is also essential that the user read and follow the “Instructions for Safe Operation” in this manual. If other equipment is operated in the shielded room it may be disturbed by the amplifier.



Der Benutzer dieses Gerätes ist dafür verantwortlich, daß die elektromagnetische Abschirmung und Filterung gewährleistet ist, welche gemäß Richtlinie 2014/30/EU notwendig ist. Das Gerät muß deshalb in einem geschirmten Raum betrieben werden, welcher eine ausreichenden Schirmung bietet, um die Emissions- und Störfestigkeitsspezifikation einzuhalten. Es werden folgenden Minimalwerte der Schirmdämpfung und Filterung in den unterschiedlichen Leistungsklassen empfohlen.

Hochfrequenzleistung	min. Schirmdämpfung
100 Watt	50 dB
101-1000 Watt	60 dB
1001-10.000 Watt	70 dB

Falls andere elektrische oder elektronische Geräte gleichzeitig mit dem Gerät betrieben werden, kann es zu Beeinflussungen kommen. Da das Gerät zur Erzeugung von Hochfrequenzenergie dient ist es daher auch unbedingt notwendig, daß der Benutzer die Sicherheitsvorschriften in der Bedienungsanleitung liest und einhält.



Il est de la responsabilité de l'utilisateur de cet équipement d'assurer la protection électromagnétique, le filtrage et l'isolation nécessaires, afin de se conformer à la directive 2014/30/EU concernant la C.E.M. Par conséquent, cet équipement doit être mis en fonctionnement dans une enceinte d'atténuation suffisante pour satisfaire aux spécifications d'émissivité et de susceptibilité. Pour une utilisation conforme, les niveaux d'atténuation minimums suivants sont suggérés en fonction de la puissance de sortie de l'équipement:

Puissance de sortie	Atténuation minimum de l'enceinte
100 Watts	50 dB
101 à 1.000 Watts	60 dB
1.001 à 10.000 Watts	70 dB

Puisque cet équipement est destiné à générer de forts niveaux R.F., il est essentiel que l'utilisateur se conforme aux instructions de sécurité indiquées dans ce manuel. Tout autre équipement en fonctionnement dans la cage de Faraday peut-être perturbé par l'amplificateur.

INSTRUCTIONS FOR SAFE OPERATION









Observe the following safety guidelines to help ensure your own personal safety and to help protect your equipment and working environment from potential damage.

INTENDED USE

This equipment is intended for general laboratory use in generating, controlling, and measuring levels of electromagnetic Radio Frequency (RF) energy. Ensure that the device is operated in a location which will control the radiated energy and will not cause injury or violate regulatory levels of electromagnetic interference.

SAFETY SYMBOLS

These symbols may appear in your user manual or on equipment.

	This symbol is marked on the equipment when it is necessary for the user to refer to the manual for important safety information. The caution symbol denotes a potential hazard. Attention must be given to the statement to prevent damage, destruction, or harm.
	Dangerous voltages are present. Use extreme care.
	Indicates a terminal intended for connection to an external conductor for protection against electrical shock in case of a fault, or the terminal of a protective earth (ground) electrode.
	Indicates invisible laser radiation—do not view directly with optical instruments.
	Indicates frame or chassis ground connection terminal.
	Indicates alternating current.
	Indicates this product must not be disposed of with your other household waste.
	Indicates that the marked surface and adjacent surfaces can attain temperatures that may be hot to the touch.

EQUIPMENT SETUP PRECAUTIONS



Review the user manual and become familiar with all safety markings and instructions. Protection provided by the equipment may be impaired if used in a manner not specified by AR RF/Microwave Instrumentation (AR).

- Follow all lifting instructions specified in this document.
- Place the equipment on a hard, level surface.
- Do not use the equipment in a wet environment, for example, near a sink, or in a wet basement.
- Position your equipment so that the power switch is easily accessible.
- Leave 10.2 cm (4 in) minimum of clearance on all vented sides of the equipment to permit the airflow required for proper ventilation. Do not restrict airflow into the equipment by blocking

any vents or air intakes. Restricting airflow can result in damage to the equipment, intermittent shut-downs or safety hazards.

- Keep equipment away from extremely hot or cold temperatures to ensure that it is used within the specified operating range.
- While installing accessories such as antennas, directional couplers and field probes, take care to avoid any exposure to hazardous RF levels.
- Ensure that nothing rests on your equipment's cables and that the cables are not located where they can be stepped on or tripped over.
- Move equipment with care; ensure that all casters and/or cables are firmly connected to the system. Avoid sudden stops and uneven surfaces.

BEFORE APPLYING POWER

Your AR equipment may have more than one power supply cable. Use only approved power cable(s). If you have not been provided with a power cable for the equipment or for any AC-powered option intended for the equipment, purchase a power cable that is approved for use in your country. The power cable must be rated for the equipment and for the voltage and current marked on the equipment's electrical ratings label.



Incorrectly installing or using an incompatible line voltage may increase the risk of fire or other hazards. To help prevent electric shock, plug the equipment and peripheral power cables into properly grounded electrical outlets. These cables are equipped with three-prong plugs to help ensure proper grounding. Do not use adapter plugs or remove the grounding prong from a cable.

Do not modify power cables or plugs. Consult a licensed electrician or AR trained service technician for equipment modifications. Always follow your local/national wiring rules.



Do not operate the equipment if there is physical damage, missing hardware, or missing panels.

SAFETY GROUND



This equipment is provided with a protective earth terminal. The mains power source to the equipment must supply an uninterrupted safety ground of sufficient size to attach wiring terminals, power cord, or supplied power cord set. ***DO NOT USE this equipment if this protection is impaired.***

INSTRUCTIONS FOR SAFE OPERATION

HAZARDOUS RF VOLTAGES

The RF voltages on the center pin of an RF output connector can be hazardous. The RF output connector should be connected to a load before AC power is applied to the equipment. Do not come into contact with the center pin of the RF output connector or accessories connected to it. Place the equipment in a non-operating condition before disconnecting or connecting the load to the RF output connector.



ACOUSTIC LIMITATIONS

If equipment noise exceeds 80dB, ear protection is required.

MAINTENANCE CAUTION

Adjustment, maintenance, or repair of the equipment must be performed only by qualified personnel. Hazardous energy may be present while protective covers are removed from the equipment even if disconnected from the power source. Contact may result in personal injury. Replacement fuses are required to be of specific type and current rating.

ENVIRONMENTAL CONDITIONS

Unless otherwise stated on the product specification sheet, this equipment is designed to be safe under the following environmental conditions:

- Indoor use
- Altitude up to 2000m
- Temperature of 5°C to 40°C
- Maximum relative humidity 80% for temperatures up to 31°C. Decreasing linearly to 50% at 40°C.
- Main supply voltage fluctuations not to exceed $\pm 10\%$ of the nominal voltage or minimum and maximum autoranging values.
- Pollution degree 2: Normally non-conductive with occasional condensation. While the equipment will not cause hazardous condition over this environmental range, its performance may vary.

EQUIPMENT CONTAINING LASERS



AR Field Probes (FL/PL Series) and Field Analyzers (FA Series) are Class 1 laser products containing embedded Class 4 lasers. Under normal use, the laser radiation is completely contained within the fiber optic cables and poses no threat of exposure. Safety interlocks ensure that the laser is not activated unless the cables are properly connected. Always exercise caution when using or maintaining laser products. Do not view directly with optical instruments.

RF ANTENNAS

- This equipment (antenna or antenna assembly) may be heavy, requiring two persons to lift. Use caution when installing or removing unit. Follow all equipment setup and lifting instructions specified in this document.
- Ensure connectors are appropriate for intended operation. Connectors are specified in the user manual and product specification sheet.
- Do not exceed the maximum RF input level stated in the specifications. Refer to the user manual and product specification sheet to determine the applicable RF levels.
- Excessive RF input could damage the equipment or connectors, causing safety hazards.
- When in operation, the RF voltages on the antenna elements can be hazardous. Do not come into contact with the antenna or elements when the RF input connector is connected to a live RF source.
- To avoid injury to personnel and accidental damage to power amplifier or antenna, disable the RF output of power amplifier before connecting or disconnecting the input connection to the antenna.
- Perform periodic inspections of antenna and field probe systems to verify calibration due date, proper operation, and overall condition of equipment.

RACK MOUNTED TWT MODELS

Some TWT models are supplied without the removable enclosure offered for benchtop use. These rack-mountable models may be supplied with either carry handles or slides and front handles installed. Follow all lifting instructions specified in this document and installation instructions supplied in the TWT user manual.

LIFTING INSTRUCTIONS FOR AR EQUIPMENT

Because most products must be handled during distribution, assembly and use, the risk of serious injury due to unsafe product handling should be a fundamental consideration of every user. An authoritative guideline for eliminating unwarranted risk of injury caused by lifting is provided by the NIOSH Work Practices (Publication #94-110) available at:



<https://www.cdc.gov/niosh/docs/94-110/pdfs/94-110.pdf>.

In general, observe the following guidelines for lifting a weight of 50 lb or more:

- Use lifting eye (for floor standing) or side handles (table top) to lift unit only.
- Use equipment of adequate capacity to lift and support unit.
- If using forklift to move unit, be sure forks are long enough to extend beyond the side of the unit.
- For additional information, follow the link specified above.

HINWEISE FÜR DEN SICHEREN GEBRAUCH









Bitte beachten Sie die folgenden Hinweise zum Schutz Ihrer persönlichen Sicherheit und um Ihre Ausrüstung und Ihren Arbeitsplatz vor möglichen Schäden zu bewahren.

VORGESEHENE VERWENDUNG

Dieses Gerät ist für den allgemeinen Einsatz im Labor bestimmt. Es dient der Erzeugung, Steuerung und Messung von elektromagnetischer Hochfrequenzenergie (RF). Stellen Sie sicher, dass das Gerät an einem Ort in Betrieb genommen wird, an dem die abgestrahlte Energie gesteuert werden kann, so dass niemand Schaden erfährt und elektromagnetische Störungen vermieden werden.

SICHERHEITSSYMBOL

Einige dieser Symbole befinden sich sowohl in der Bedienungsanleitung als auch auf dem Gerät selbst.

	Dieses Symbol befindet sich auf dem Gerät und weist darauf hin, dass der Nutzer an dieser Stelle wichtige Sicherheitsinformationen in der Bedienungsanleitung studieren soll. Das Warnsymbol weist auf eine mögliche Gefahr hin. Zur Vermeidung von Personen- oder Sachschäden gilt es, die Hinweise zu beachten.
	Gefährliche elektrische Spannungen sind vorhanden. Höchste Vorsicht ist geboten.
	Weist darauf hin, dass an dieser Stelle eine Klemme für den Anschluss an einen Außenleiter anzubringen ist, zum Schutz vor einem Stromschlag oder im Fall einer auftretenden Störung, oder dass eine Klemme anzubringen ist, die als schützende Erdungselektrode fungiert.
	Zeigt unsichtbare Laserstrahlung an – nicht direkt hineinschauen.
	Weist auf eine Rahmen- oder Chassis-Anschlussklemme hin.
	Zeigt Wechselstrom an.
	Weist darauf hin, dass dieses Produkt nicht mit Ihrem restlichen Hausmüll entsorgt werden darf.
	Weist darauf hin, dass die markierte Oberfläche und benachbarte Flächen extrem heiße Temperaturen erreichen können und daher nicht angefasst werden sollten.

SICHERHEITSHINWEISE FÜR DEN AUFBAU DES GERÄTS



Lesen Sie die Bedienungsanleitung aufmerksam durch und machen Sie sich mit allen Sicherheitsmarkierungen und Anweisungen vertraut. Die Sicherheit kann beeinträchtigt sein, falls das Gerät in einer anderen Weise verwendet wird, als von der AR RF/Microwave Instrumentation (AR) vorgegeben ist.

- Zum Heben und Transport folgen Sie allen in dieser Anleitung angegebenen Anweisungen.
- Platzieren Sie das Gerät auf einer harten, ebenen Oberfläche.
- Verwenden Sie das Gerät nicht in feuchter Umgebung, zum Beispiel in der Nähe einer Spüle oder in einem feuchten Keller.
- Platzieren Sie Ihr Gerät so, dass der Netzschalter leicht zugänglich ist.

- Halten Sie einen Mindestabstand von 10,2 cm (4 in) auf allen belüfteten Seiten des Geräts ein, um eine ausreichende Luftzirkulation zu gewährleisten. Beeinträchtigen Sie den Luftstrom des Geräts nicht, indem Sie Lüftungsöffnungen oder den Lufteinlass blockieren. Wird der Luftstrom eingeschränkt, kann dies zu Schäden am Gerät, periodischen Abschaltungen und anderen Gefahren führen.
- Halten Sie das Gerät von extrem heißen oder kalten Temperaturen fern, um sicherzustellen, dass es nur in dem vorgeschriebenen Bedienungsbereich verwendet wird.
- Achten Sie beim Installieren von Zubehör wie Antennen, Richtungskupplungen und Feldsonden darauf, dass sie keinen gefährlichen HF-Werten ausgesetzt sind.
- Stellen Sie sicher, dass nichts auf den Kabeln Ihres Geräts steht. Bringen Sie die Kabel so an, dass niemand darauf treten oder darüber stolpern kann.
- Seien Sie vorsichtig, wenn Sie das Gerät bewegen. Achten Sie darauf, dass alle Rollen und/oder Kabel fest mit dem System verbunden sind. Vermeiden Sie plötzliche Stopps und Oberflächen, die nicht eben sind.

BEVOR SIE DAS GERÄT ANSCHLIESSEN

Ihre AR-Ausrüstung hat möglicherweise mehr als ein Stromversorgungskabel. Verwenden Sie nur zugelassene Stromkabel. Falls Sie kein Stromkabel oder AC-Netzkabel für dieses Gerät haben, kaufen Sie ein Stromkabel, das für den Einsatz in Ihrem Land zugelassen ist. Das Stromkabel muss für das Gerät, die Spannung und den Strom, die auf dem elektrischen Kennzeichnungsetikett des Geräts markiert sind, zugelassen sein.



Bei einer fehlerhaften Installation oder falls eine Netzspannung verwendet wird, die nicht mit dem Gerät kompatibel ist, erhöht sich die Brandgefahr. Auch andere Gefahren können auftreten. Um einen Stromschlag zu verhindern, schließen Sie das Gerät und die peripheren Stromkabel an ordnungsgemäß geerdete Steckdosen an. Die Kabel sind mit dreipoligen Steckern ausgestattet, um eine korrekte Erdung zu gewährleisten. Verwenden Sie keine Adapter. Entfernen Sie niemals die Erdungsstange eines Kabels.

Modifizieren Sie niemals die Stromkabel oder Stecker. Konsultieren Sie einen lizenzierten Elektriker oder AR-ausgebildeten Servicetechniker, falls Veränderungen am Gerät durchgeführt werden müssen. Halten Sie sich stets an die nationalen/örtlichen Verdrahtungsregeln.



Schalten Sie das Gerät nicht ein, falls es äußerlich beschädigt ist oder Hardware-Teile oder Konsolen fehlen.

SYSTEMERDUNG



Dieses Gerät ist mit einer Schutzerdklemme ausgestattet. Die Netzstromquelle muss dem Gerät eine ununterbrochene Systemerdung von ausreichender Größe zur Verfügung stellen, damit Kabelklemmen, Netzkabel oder mitgeliefertes Netzkabel ordentlich befestigt werden können. **VERWENDEN SIE DIESES GERÄT NICHT, wenn dieser Schutz beeinträchtigt ist.**

HINWEISE FÜR DEN SICHEREN GEBRAUCH

GEFÄHRLICHE HF-SPANNUNGEN



Die HF-Spannungen am mittleren Pin eines HF-Ausgangsanschlusses können gefährlich sein. Der HF-Ausgangsanschluss sollte an eine Last angeschlossen werden, bevor das Gerät ans Stromnetz angeschlossen wird. Kommen Sie nicht mit dem Mittelstift des HF-Ausgangsanschlusses oder dem damit verbundenen Zubehör in Kontakt. Bevor Sie die Last vom HF-Ausgang trennen oder diese anschließen, stellen Sie das Gerät in einen nicht betriebsfähigen Zustand.

HÖRSCHUTZ

Sollten die Geräusche, die das Gerät verursacht, 80dB überschreiten, ist Gehörschutz erforderlich.

WARTUNGSHINWEISE

Einstellung, Wartung oder Reparaturen der Ausrüstung dürfen nur von qualifizierten Fachleuten durchgeführt werden. Gefährliche Spannungen können auftreten, wenn Schutzabdeckungen vom Gerät entfernt werden, auch wenn es nicht an die Stromquelle angeschlossen ist. Kontakt kann zu Verletzungen führen. Es können nur bestimmte Ersatzsicherungen mit speziellem Nennstrom verwendet werden.

UMGEBUNGSBEDINGUNGEN

Sofern auf dem Produktspezifikations-Blatt nichts anderes angegeben ist, ist dieses Gerät unter folgenden Bedingungen sicher einsetzbar:

- Gebrauch in Innenräumen
- Höhe bis zu 2000m
- Temperaturen von 5°C bis 40°C
- Maximale relative Luftfeuchtigkeit 80% bei Temperaturen bis 31°C. Lineare Abnahme auf 50% bei 40°C.
- Netzspannungsschwankungen sollen nicht mehr als $\pm 10\%$ der Nennspannung oder der minimal und maximal eingestellten Werte betragen.
- Verschmutzungsgrad 2: Normalerweise nichtleitfähige Verschmutzung mit gelegentlicher Kondensation. Das Gerät wird bei Einsatz in diesem Bereich keine Gefahr verursachen, die Leistung kann dennoch variieren.

LASER-INFORMATION



AR - Feldsonden (FL/PL-Serie) und Feldanalysatoren (FA-Serie) sind Laserprodukte der Klasse 1 mit eingebetteten Klasse-4-Lasern. Bei normalem Gebrauch kann der Laserstrahlung nicht aus den Glasfaserkabel herausdringen. Sicherheitsverriegelungen sorgen dafür, dass der Laser nur aktiviert wird, wenn die Kabel richtig angeschlossen sind. Lassen Sie stets Vorsicht walten bei der Verwendung oder Wartung von Laserprodukten. Niemals direkt hineinschauen.

HF-ANTENNEN

- Die Ausrüstung (Antenne oder Antennenmontage) ist mitunter schwer. Die Montage erfordert daher oft zwei Personen. Folgen Sie allen in diesem Dokument angegebenen Anweisungen zur Anbringung.
- Stellen Sie sicher, dass alle Anschlüsse für den beabsichtigten Betrieb geeignet sind. Informationen zu den Anschlüssen erhalten Sie im Benutzerhandbuch und im Produktspezifikationsblatt.
- Überschreiten Sie nicht den in Spezifikationen angegebenen maximalen HF-Eingangspegel. Informationen zum geeigneten HF-Pegel erhalten Sie im Benutzerhandbuch und im Produktspezifikationsblatt.
- Ein übermäßiger HF-Eingang könnte das Gerät oder die Anschlüsse beschädigen, was zu Sicherheitsrisiken führt.
- Im Betrieb können die HF-Spannungen an den Antennenelementen gefährlich sein. Kommen Sie nicht mit der Antenne oder Antennenelementen in Kontakt, wenn der HF-Eingang an eine live-HF-Quelle angeschlossen ist.
- Um Verletzungen an Personen, am Leistungsverstärker oder der Antenne zu vermeiden, deaktivieren Sie den HF-Ausgang des Leistungsverstärkers, bevor sie die Eingangsverbindung an die Antenne anschließen oder trennen.
- Kontrollieren Sie die Antennen und die Feldsonde regelmäßig, um die nächstfällige Kalibrierung, den ordnungsgemäßen Betrieb und den Gesamtzustand der Ausrüstung zu überprüfen.

RACK MONTIERBARE TWT-MODELLE

Einige TWT-Modelle kommen ohne die abnehmbare Überdachung, die zur Verwendung als Tischgerät dient. Diese rack-montierbaren Modelle verfügen entweder über installierte Tragegriffe oder Rutschflächen. Befolgen Sie alle in diesem Dokument angegebenen Hebehinweise sowie die Installationsanweisungen in der TWT-Bedienungsanleitung.

HEBEANWEISUNGEN FÜR AR-GERÄTE

Die meisten Geräte müssen während des Versands, der Montage und des Gebrauchs transportiert werden. Jeder Nutzer sollte sich über das Risiko von schweren Verletzungen durch unsachgemäße Produkthandhabung bewusst sein. Leitlinien zur Beseitigung von vermeidbaren Verletzungsrisikos, die beim Heben entstehen können, werden in den NIOSH-Arbeitspraktiken (Veröffentlichung # 94-110) zur Verfügung gestellt:



<https://www.cdc.gov/niosh/docs/94-110/pdfs/94-110.pdf>

Beachten folgende, allgemeine Richtlinien zum Heben eines Gewichts von 50 Pfund oder mehr:

- Verwenden Sie zum Heben der Einheit eine Hebeöse (für Platzierung auf dem Boden) oder Seitengriffe (für Platzierung auf einer Arbeitsplatte).
- Verwenden Sie Geräte mit ausreichender Kapazität zum Heben und Stützen.
- Falls Sie einen Gabelstapler verwenden, achten Sie darauf, dass die Gabeln lange genug sind und über die Seiten der Einheit hinausreichen.
- Für weitere Informationen folgen Sie dem oben angegebenen Link.

INSTRUCTIONS POUR UN FONCTIONNEMENT EN TOUTE SÉCURITÉ









Respectez les consignes de sécurité suivantes pour veiller à votre propre sécurité et vous aider à protéger votre équipement et votre milieu de travail de dommages potentiels.

USAGE PRÉVU

Cet équipement est prévu pour un usage général en laboratoire afin de générer, contrôler et mesurer les niveaux d'énergie de radiofréquence (RF) électromagnétique. Assurez-vous que l'appareil est utilisé dans un endroit qui contrôlera l'énergie rayonnante et ne causera pas de blessure, ni ne violera les niveaux réglementaires d'interférence électromagnétique.

SYMBOLES DE SÉCURITÉ

Ces symboles peuvent apparaître dans votre manuel d'utilisation ou sur l'équipement.

	Ce symbole est apposé sur l'équipement lorsque l'utilisateur doit se référer au manuel pour des informations importantes concernant la sécurité. Le symbole de mise en garde indique un danger potentiel. Vous devez accorder une attention à la déclaration pour éviter tout dommage, destruction ou blessure.
	Présence de tensions dangereuses, soyez très prudent.
	Indique une borne de connexion d'un conducteur externe pour une protection contre l'électrocution en cas de défaillance ou la borne d'une électrode de mise à la terre de protection.
	Indique un rayonnement laser invisible – ne regardez pas directement avec des instruments optiques.
	Indique la borne de connexion de la mise à la terre du cadre ou du châssis.
	Indique un courant alternatif.
	Indique que ce produit ne doit pas être jeté avec vos autres déchets ménagers.
	Indique que la surface marquée et les surfaces adjacentes peuvent atteindre des températures qui risquent d'être chaudes au toucher.

PRÉCAUTIONS D'INSTALLATION DE L'ÉQUIPEMENT

 Lisez le manuel d'utilisateur et familiarisez-vous avec tous les marquages et consignes de sécurité. La protection fournie par l'équipement peut être affaiblie s'il est utilisé d'une manière non indiquée par AR RF/instrumentation à hyperfréquence (AR).

- Respectez toutes les instructions de levage indiquées dans ce document.
- Placez l'équipement sur une surface dure et plane.

- N'utilisez pas l'équipement dans un environnement humide, par exemple près d'un lavabo, ou dans un sous-sol humide.
- Positionnez votre équipement de sorte que l'interrupteur d'alimentation soit facilement accessible.
- Laissez un espace minimal de 10,2 cm (4 in) de tous les côtés ventilés de l'équipement pour permettre le flux d'air nécessaire à une bonne ventilation. Ne limitez pas le flux d'air allant dans l'équipement en bloquant tout évent ou entrée d'air. La restriction du flux d'air peut endommager l'équipement, causer des coupures intermittentes ou des dangers pour la sécurité.
- Tenez l'équipement à l'écart de températures extrêmement chaudes ou froides pour veiller à ce qu'il soit utilisé dans la plage de fonctionnement indiquée.
- Lorsque vous installez des accessoires tels que des antennes, des coupleurs directionnels et des sondes de champ, prenez soin d'éviter toute exposition à des niveaux RF dangereux.
- Assurez-vous que rien n'est posé sur les câbles de votre équipement et que les câbles ne se trouvent pas à des endroits où l'on peut marcher dessus ou trébucher.
- Déplacez l'équipement avec soin ; veillez à ce que tous les câbles et/ou roulettes soient solidement raccordés au système. Évitez les arrêts brusques et les surfaces irrégulières.

AVANT LA MISE SOUS TENSION

Votre équipement AR peut disposer de plus d'un câble d'alimentation électrique. Utilisez uniquement un ou des câbles d'alimentation approuvés. Si un câble d'alimentation ne vous a pas été fourni avec l'équipement ou pour toute option alimentée en courant alternatif prévue pour l'équipement, achetez un câble d'alimentation qui est approuvé pour être utilisé dans votre pays. Le câble d'alimentation doit être prévu pour l'équipement et pour le courant et la tension indiqués sur l'étiquette de classement électrique de l'équipement.



Installer ou utiliser de façon incorrecte une tension de ligne incompatible peut augmenter le risque d'incendie ou d'autres dangers. Pour aider à éviter toute électrocution, branchez l'équipement et les câbles d'alimentation périphériques dans des prises électriques correctement mises à la terre. Ces câbles sont équipés de prises à trois broches pour veiller à une bonne mise à la terre. N'utilisez pas d'adaptateur de prise, ni ne retirez la broche de mise à la terre d'un câble.

Ne modifiez pas les câbles ou les prises d'alimentation. Consultez un électricien agréé ou un technicien d'entretien AR qualifié pour les modifications d'équipement. Respectez toujours les règles locales/nationales de câblage.



N'utilisez pas l'équipement s'il est physiquement endommagé ou s'il manque des pièces ou des panneaux.

MISE À LA TERRE DE SÉCURITÉ



Cet équipement est fourni avec une borne de mise à la terre de protection. La source d'alimentation secteur à l'équipement doit fournir une mise à la terre de sécurité ininterrompue de taille suffisante pour attacher les bornes de câblage, le cordon d'alimentation ou l'ensemble de câbles d'alimentation fourni. **N'UTILISEZ PAS cet équipement si cette protection est affaiblie.**

INSTRUCTIONS POUR UN FONCTIONNEMENT EN TOUTE SÉCURITÉ

TENSIONS RF DANGEREUSES

Les tensions RF sur la broche centrale d'un connecteur de sortie RF peuvent être dangereuses. Le connecteur de sortie RF doit être connecté à une charge avant que l'équipement ne reçoive l'alimentation en courant alternatif. N'entrez pas en contact avec la broche centrale du connecteur de sortie RF ou des accessoires raccordés à celle-ci. L'équipement doit être dans un état de non fonctionnement avant de déconnecter ou de connecter la charge au connecteur de sortie RF.



LIMITES ACOUSTIQUES

Si le bruit de l'équipement dépasse 80dB, une protection auditive est nécessaire.

AVERTISSEMENT CONCERNANT L'ENTRETIEN

Le réglage, l'entretien ou la réparation de l'équipement doivent être effectués uniquement par un personnel qualifié. Une énergie dangereuse peut être présente lorsque les couvercles de protection sont retirés de l'équipement, même si celui-ci est déconnecté de la source d'alimentation. Un contact peut causer des blessures. Les fusibles de remplacement doivent être d'un type et courant nominal spécifiques.

CONDITIONS ENVIRONNEMENTALES

Sauf mention contraire sur la fiche signalétique du produit, cet équipement est conçu pour être sécuritaire dans les conditions environnementales suivantes :

- Utilisation à l'intérieur
- Altitude jusqu'à 2000 m
- Température de 5°C à 40°C
- Humidité relative maximale de 80 % pour les températures jusqu'à 31°C. Décroissance linéaire à 50 % à 40°C.
- Les fluctuations de tension d'alimentation principale ne doivent pas dépasser ± 10 % de la tension nominale ou des valeurs d'autorégulation minimales et maximales.
- Degré de pollution 2 : Normalement non conducteur avec une condensation occasionnelle. Bien que l'équipement ne cause pas de condition dangereuse dans cette gamme environnementale, sa performance peut varier.

ÉQUIPEMENT CONTENANT DES LASERS



Les sondes de champ AR (série FL/PL) et les analyseurs de champ (série FA) sont des produits laser de classe 1 contenant des lasers intégrés de classe 4. Lors d'une utilisation normale, le rayonnement laser est entièrement contenu dans les câbles à fibres optiques et ne pose aucun risque d'exposition. Des verrouillages de sécurité veillent à ce que le laser ne soit pas activé à moins que les câbles ne soient correctement raccordés. Soyez toujours prudent lorsque vous utilisez ou entretenez des produits laser. Ne regardez pas directement avec des instruments optiques.

ANTENNES RF

- Cet équipement (antenne ou ensemble antenne) peut être lourd nécessitant deux personnes pour le soulever. Soyez prudent lorsque vous installez ou retirez l'unité. Respectez toutes les instructions concernant l'installation et le levage de l'équipement indiquées dans ce document.

- Assurez-vous que les connecteurs sont appropriés pour l'utilisation prévue. Les connecteurs sont indiqués dans le manuel d'utilisation et la fiche signalétique du produit.
- Ne dépassez pas le niveau d'entrée RF maximal indiqué dans les spécifications. Référez-vous au manuel d'utilisation et à la fiche signalétique du produit pour déterminer les niveaux RF applicables.
- Une entrée RF excessive pourrait endommager l'équipement ou les connecteurs causant des dangers pour la sécurité.
- Lorsque l'équipement fonctionne, les tensions RF sur les éléments de l'antenne peuvent être dangereuses. N'entrez pas en contact avec l'antenne ou les éléments lorsque le connecteur d'entrée RF est connecté à une source RF active.
- Pour éviter que le personnel ne se blesse et que l'amplificateur de puissance ou l'antenne ne soit endommagé, désactivez la sortie RF de l'amplificateur de puissance avant de brancher ou débrancher la connexion d'entrée à l'antenne.
- Effectuez des inspections périodiques de l'antenne et des systèmes de sondes de champ pour vérifier la date d'échéance de la calibration, le bon fonctionnement et l'état global de l'équipement.

MODÈLES TWT MONTÉS SUR BÂTI

Certains modèles TWT sont fournis sans le boîtier amovible proposé pour l'utilisation sur un plan de travail. Ces modèles montés sur bâti peuvent être fournis avec des poignées de transport ou des coulisses et poignées frontales. Respectez toutes les instructions de levage indiquées dans ce document et les instructions d'installation fournies dans le manuel d'utilisation TWT.

INSTRUCTIONS DE LEVAGE POUR L'ÉQUIPEMENT AR

Comme la plupart des produits doivent être manipulés pendant la distribution, l'assemblage et l'utilisation, le risque de blessures graves en raison d'une manipulation dangereuse du produit doit être une considération fondamentale pour chaque utilisateur. Une directive faisant autorité pour éliminer le risque injustifié de blessures causées par le levage est fournie par les méthodes de travail de NIOSH (publication n° 94-110) disponibles sur :



<https://www.cdc.gov/niosh/docs/94-110/pdfs/94-110.pdf>.

De façon générale, respectez les directives suivantes pour lever un poids de 50 lb (22 kg) ou plus :

- Utilisez uniquement l'anneau de levage (si posé au sol) ou les poignées latérales (si sur la table) pour soulever l'unité.
- Utilisez un équipement de capacité adéquate pour soulever et supporter l'unité.
- Si vous utilisez un chariot élévateur pour déplacer l'unité, assurez-vous que les fourches sont assez longues pour s'étendre au-delà du côté de l'unité.
- Pour plus d'informations, suivez le lien indiqué ci-dessus.

INSTRUCTIES VOOR VEILIG GEBRUIK



Neem de volgende veiligheidsrichtlijnen in acht om uw persoonlijke veiligheid te helpen waarborgen en uw apparaat en werkomgeving tegen mogelijke schade te beschermen.

BEOOGD GEBRUIK

Dit apparaat is bedoeld voor algemeen laboratoriumgebruik bij het genereren, regelen en meten van niveaus van elektromagnetische radiofrequentie(RF)-energie. Zorg ervoor dat het apparaat wordt gebruikt op een locatie die de uitgestraalde energie controleert, geen letsel veroorzaakt of de reglementaire niveaus van elektromagnetische interferentie schendt.

VEILIGHEIDSSYMBOLEN

Deze symbolen kunnen in uw gebruikershandleiding of op uw apparaat verschijnen.

	Dit symbool staat op het apparaat als de gebruiker de handleiding moet raadplegen voor belangrijke veiligheidsinformatie. Het waarschuwingssymbool geeft een mogelijk gevaar aan. Er moet aandacht worden besteed aan de verklaring om schade, vernietiging of letsel te voorkomen.
	Er zijn gevaarlijke elektrische spanningen aanwezig. Wees uiterst voorzichtig.
	Wijst op een terminal aan die bedoeld is voor aansluiting op een externe geleider voor bescherming tegen elektrische schokken in het geval van een storing, of de terminal van een veiligheidselektrode (aarding).
	Wijst op een onzichtbare laserstraling - bekijk niet rechtstreeks met optische instrumenten.
	Wijst op het frame of het chassis van de aardingsterminal.
	Wijst op wisselstroom.
	Geeft aan dat dit product niet bij het huishoudelijk afval mag worden weggegooid.
	Geeft aan dat het gemarkeerde oppervlak en de aangrenzende oppervlakken temperaturen kunnen bereiken, die warm aanvoelen.

VOORZORGSMAATREGELEN BIJ DE INSTALLATIE VAN HET APPARAAT



Raadpleeg de gebruikershandleiding en leer alle veiligheidsmarkeringen en -instructies kennen. De bescherming die door het apparaat wordt geboden, kan worden belemmerd bij gebruik op een manier die niet wordt vermeld door AR RF/Microwave Instrumentation (AR).

- Respecteer alle tilinstructies die in dit document vermeld zijn.
- Plaats het apparaat op een hard, waterpas oppervlak.
- Gebruik het apparaat niet in een natte omgeving, bijvoorbeeld in de buurt van een gootsteen of in een vochtige kelder.
- Plaats uw apparaat zodanig dat de aan/uit-schakelaar gemakkelijk bereikbaar is.

Revisie 0517

- Laat een vrije ruimte van 10,2 cm (4 inch) aan alle geventileerde zijden van het apparaat om de luchtstroom die nodig is voor goede ventilatie mogelijk te maken. Belemmer de luchtstroom in het apparaat niet door ventilatieopeningen of luchtinlaten te blokkeren. Het belemmeren van de luchtstroom kan leiden tot schade aan het apparaat, onregelmatige uitval van veiligheidscrisis's.
- Houd het apparaat uit de buurt van extreem hoge of lage temperaturen om ervoor te zorgen dat het apparaat binnen het gespecificeerde werkbereik wordt gebruikt.
- Bij de installatie van accessoires zoals antennes, directionele koppelingen en terreinsondes, moet u ervoor zorgen dat blootstelling aan gevaarlijke RF-niveaus wordt voorkomen.
- Zorg ervoor dat er niets op de kabels van uw apparaat rust en dat de kabels zich niet op een plaats bevinden, waar er op getrapt kan worden of waar er over gestruikeld kan worden.
- Verplaats de apparatuur voorzichtig; zorg ervoor dat alle zwenkwielen en/of kabels stevig op het systeem zijn aangesloten. Vermijd plotselinge stops en oneffen oppervlakken.

VOOR HET OPZETTEN VAN DE STROOM

Uw AR-apparatuur kan meer dan een netvoedingskabel bezitten. Gebruik alleen goedgekeurde netvoedingskabel(s). Koopt een netvoedingskabel die is goedgekeurd voor gebruik in uw land als u geen netvoedingskabel hebt ontvangen voor de apparatuur of voor een door wisselstroom aangedreven optie, die bedoeld is voor de apparatuur. De netvoedingskabel moet geschikt zijn voor het apparaat en voor de spanning en stroomsterkte die op het label met de elektrische classificatie van het apparaat staat vermeld.



Het verkeerd installeren of gebruiken van een incompatibele netspanning kan het risico op brand of andere gevaren verhogen. Sluit het apparaat en de perifere netvoedingskabels aan op geaarde stopcontacten om elektrische schokken te helpen voorkomen. Deze kabels zijn uitgerust met driepolige stekkers om voor een goede aarding te zorgen. Gebruik geen adapterstekkers of verwijder de aardingspen van een kabel niet.

Pas geen netvoedingskabels of stekkers aan. Raadpleeg een bevoegde elektricien of een door AR opgeleide servicemonteur voor aanpassingen van de apparatuur. Respecteer altijd uw lokale/nationale bedravingsreglementering.



Gebruik de apparatuur niet als er sprake is van fysieke schade, ontbrekende hardware of ontbrekende panelen.

AARDING



Deze apparatuur is voorzien van een beschermende aardingsterminal. De stroombron van de apparatuur moet een ononderbroken veiligheidsaarding van voldoende grootte leveren om de aansluitklemmen, de netvoedingskabel of de meegeleverde netvoedingskabelset aan te sluiten. **GEBRUIK dit apparaat NIET als deze bescherming is beschadigd.**

INSTRUCTIES VOOR VEILIG GEBRUIK

GEVAARLIJKE RF-SPANNINGEN

De RF-spanning op de middelste pin van een RF-outputconnector kan gevaarlijk zijn. De RF-uitgangconnector moet op een massa worden aangesloten voordat er wisselstroom op het apparaat wordt geplaatst. Raak de middelste pin van de RF-outputconnector of de accessoires die erop zijn aangesloten, niet aan. Plaats het apparaat in een niet-werkende staat voordat u de massa loskoppelt of verbindt met de RF-outputconnector.



AKOESTISCHE BEPERKINGEN

Als het geluid van het apparaat 80dB overschrijdt, is gehoorbescherming vereist.

ONDERHOUD WAARSCHUWING

Aanpassing, onderhoud of reparatie van de apparatuur mag alleen worden uitgevoerd door gekwalificeerd personeel. Er kan gevaarlijke energie aanwezig zijn terwijl beschermende afdekkingen van de apparatuur worden verwijderd, zelfs als deze van de stroombron is losgekoppeld. Contact kan tot persoonlijk letsel leiden. Wisselzekeringen moeten van het hetzelfde type en dezelfde stroomsterkte zijn.

OMGEVINGSVOORWAARDEN

Tenzij anders op het productspecificatieblad is vermeld, is dit apparaat ontworpen om veilig te zijn onder de volgende omgevingsomstandigheden:

- Binnengebruik
- Hoogte tot 2000 m
- Temperatuur van 5 °C to 40 °C
- Maximale relatieve vochtigheid 80% voor temperaturen tot 31 °C. Lineair afnemend tot 50% bij 40 °C.
- Schommelingen in de netspanning mogen niet groter zijn dan ± 10 % van de nominale spanning of minimum en maximum autobereikwaarden.
- Vervuilinggraad 2: Normaal niet-geleidend met incidentele condensatie. Hoewel het apparaat geen gevaarlijke toestand veroorzaakt boven dit omgevingsbereik, kunnen de prestaties variëren.

APPARAAT DAT LASERS BEVAT



AR-terreinsondes (FL/PL-serie) en terreinanalysatoren (FA-serie) zijn laserproducten van klasse 1 met ingesloten klasse 4-lasers. Bij normaal gebruik is de laserstraling volledig vervat in de glasvezelkabels en vormt ze geen bedreiging voor blootstelling. Veiligheidsvergrendelingen zorgen ervoor dat de laser niet wordt geactiveerd, tenzij de kabels correct zijn aangesloten. Wees altijd voorzichtig bij het gebruik of het onderhoud van laserproducten. Bekijk niet rechtstreeks met optische instrumenten.

RF-ANTENNES

- Dit apparaat (antenne of antenne-set) kan zwaar zijn, waardoor er twee personen nodig zijn om het op te tillen. Wees voorzichtig bij het installeren of verwijderen van het apparaat. Respecteer alle instructies voor het instellen en optillen van de apparatuur, die in dit document worden vermeld.
- Zorg ervoor dat de connectoren geschikt zijn voor de beoogde werking. De connectoren worden gespecificeerd in de gebruikershandleiding en in het productspecificatieblad.
- Overschrijd het maximale RF-ingangsniveau niet, dat in de specificaties is vermeld. Raadpleeg de gebruikershandleiding en het productspecificatieblad om de toepasselijke RF-niveaus te bepalen.
- Een overmatige RF-input kan het apparaat of de connectoren beschadigen en veiligheidsrisico's veroorzaken.
- De RF-spanningen op de antenne-elementen kunnen gevaarlijk zijn tijdens het gebruik. Raak de antenne of elementen niet aan wanneer de RF-ingangconnector is aangesloten op een actieve RF-bron.
- Om persoonlijk letsel en onopzettelijke schade aan de vermogensversterker of antenne te voorkomen, schakelt u de RF-output van de vermogensversterker uit voordat u de inputaansluiting op de antenne aansluit of loskoppelt.
- Voer periodieke inspecties uit van de antenne- en terreinsondesystemen om de vervaldatum van de kalibratie, de juiste werking en de algehele conditie van de apparatuur te controleren.

IN EEN REK GEMONTEERDE TWT-MODELLEN

Sommige TWT-modellen worden geleverd zonder de verwijderbare behuizing die wordt aangeboden voor gebruik als tafelmodel. Deze modellen die in een rek kunnen worden gemonteerd, kunnen worden geleverd met handgrepen of sledes en handgrepen die aan de voorkant zijn geïnstalleerd. Volg alle tilinstructies in dit document en de installatie-instructies in de gebruikershandleiding van de TWT.

TILINSTRUCTIES VOOR AR-APPARATUUR

Omdat de meeste producten tijdens de distributie, de assemblage en het gebruik moeten worden behandeld, moet het risico op ernstig letsel als gevolg van een onveilige behandeling van het product een fundamentele overweging voor elke gebruiker zijn. Een gezaghebbende richtlijn voor het elimineren van ongerechtvaardigd risico op letsel veroorzaakt door tillen, wordt aangeboden door de NIOSH-Work Practices (publicatie # 94-110) en is beschikbaar op:



<https://www.cdc.gov/niosh/docs/94-110/pdfs/94-110.pdf>.

Neem in het algemeen de volgende richtlijnen in acht voor het optillen van een gewicht van 25 kg of meer:

- Gebruik alleen het hijsorg (vloermodel) of de zijhandgrepen (tafelmodel) om de eenheid op te tillen.
- Gebruik apparatuur met voldoende capaciteit om de eenheid op te tillen en te ondersteunen.
- Als u een vorkheftruck gebruikt om de eenheid te verplaatsen, zorg er dan voor dat de vorken lang genoeg zijn om tot voorbij de zijkant van het eenheid uit te steken.
- Volg de link hierboven voor meer informatie.

TABLE OF CONTENTS

TABLE OF CONTENTS	i
1. GENERAL INFORMATION	1
1.1 General Description.....	1
1.2 Specifications	1
1.3 Installation.....	1
1.3.1 Location.....	1
1.3.2 Primary Power.....	2
1.4 RF Connections.....	3
1.4.1 Amplifier Input Connector	3
1.4.2 Amplifier Output Connector	3
1.4.3 RF Sample Ports.....	3
2. OPERATING INSTRUCTIONS	7
2.1 General	7
2.2 Control and Indicator Functions.....	7
2.2.1 Keylock Switch	7
2.2.2 POWER Switch.....	8
2.2.3 Main Power	9
2.2.4 RF ON/OFF.....	9
2.2.5 RESET Function	10
2.3 Digital Control Panel (DCP) Operations.....	10
2.3.1 RF GAIN Control.....	11
2.4 Inputs and Outputs	11
2.4.1 RF Input.....	11
2.4.2 RF Output.....	12
2.4.3 IEEE-488, USB, and RS-232 Interfaces.....	12
2.4.4 Safety Interlock Connector.....	12
2.5 Amplifier Operation	12
2.5.1 Local Operation.....	12
2.6 Remote Operation	13
2.6.1 IEEE-488 (GPIB) Communication	13
2.6.1.1 Setting the IEEE-488 (GPIB) Address	14
2.6.2 RS-232 Communication.....	14
2.6.3 Fiber-Optic Communication.....	15
2.6.4 USB Communication	16
2.6.5 Ethernet Communication.....	16
2.6.6 Remote Commands	17
2.6.6.1 Power On/Off.....	18
2.6.6.2 RF On/Off.....	18
2.6.6.3 Reset Faults.....	18
2.6.6.4 Mode Select	19
2.6.6.5 Level Adjust.....	19
2.6.6.6 Identity	20
2.6.6.7 IO Board Firmware Revision.....	20
2.6.6.8 Machine State	21
2.6.6.9 State	22
2.6.6.10 Forward Power.....	23

2.6.6.11	Reverse Power	23
2.6.6.12	RF Gain.....	24
2.6.6.13	Faults (5000A225B)	24
2.6.6.14	Operating Hours (RF On)	26
2.6.6.15	Operating Hours (Power On).....	26
2.6.6.16	AC Power-On Defaults	27
3.	THEORY OF OPERATION.....	29
3.1	Introduction	29
3.2	RF Amplifier Operation	29
3.2.1	A1 Pre-Amplifier Assembly.....	29
3.2.1.1	A1 Pre-Amplifier Assembly	29
3.2.1.2	A2 2W Amplifier Assembly	29
3.2.2	A2 125W 400MHz Module Assembly.....	30
3.2.3	A19 Four-Way Splitter.....	30
3.2.4	A20-A23 Four-Way Splitter.....	30
3.2.5	A1-A16 Final Module Assembly	30
3.2.6	A25-A27 Four-Way Combiner	31
3.2.7	A28 Four-Way Combiner.....	31
3.2.8	A29 Bi-Directional Coupler	31
3.2.9	A3 Detector	31
3.3	Power Supplies.....	31
3.4	Control System.....	32
3.4.1	A5 Control/Fault Board.....	32
3.4.2	A1 Interface Board	32
3.4.3	A4 ALC.....	32
3.5	Sample Ports.....	32
4.	MAINTENANCE	33
4.1	General Maintenance Information.....	33
4.2	Disassembly Procedure	33
4.3	Cooling System	34
4.4	Troubleshooting	34
4.4.1	General - Reading Faults.....	35
4.4.2	The Unit Cannot Be Operated Remotely.....	35
4.4.3	Thermal Fault (Schematic 10049587).....	35
4.4.3.1	Flow Fault (Schematics 10049587, 10049584)	36
4.4.3.2	Level Fault (Schematic 10049587, 10049584).....	36
4.4.4	Interlock Fault	36
4.4.4.1	Interlock Fault.....	36
4.4.4.2	AC Interlock Fault	37
4.4.5	Power Supply Faults (Schematic 10049587, 10048584)	37
4.4.5.1	PDU PS1 Fault (POWER FAIL)	37
4.4.5.2	PS1 and PS2 Rack (A, B, C, D) Fault (POWER FAIL)	37
4.4.6	Amplifier Faults (Diagrams 10049038, 10045130)	37
4.4.7	ALC Fault.....	37
4.4.8	Low or No Power Output (DC Tests) (Schematics 10048570, 10049170).....	38
4.4.9	Low or No Power Output (RF Test).....	39
4.5	Locating and Replacing Modules.....	40
Appendix A.	Installing Software Upgrades.....	43

FIGURES

1-1	AC Line Cord Installation	2
2-1	Model 5000A225B Front Panel	8
2-2	Model 5000A225B Rear Panel.....	9
2-3	Menu Map	11
4-1	Typical Response at 0dBm Input	39
4-2	Typical Response at -20dBm Input	39
4-3	5000A225B Right Side, Modules A1-A8	40
4-4	Connectors.....	40
4-5	SMA Module Input	41
4-6	Final Module RF Output	41
4-7	RF Module.....	42

TABLES

2-1	RS-232 Port Settings	14
2-2	RS-232 (DCE) Port Pinout Diagram DB-9 Female	14
2-3	Fiber-Optic Serial Port Settings	15
2-4	Relationship between DCP Controls and Remote Communication	17

1. GENERAL INFORMATION

1.1 GENERAL DESCRIPTION

The Model 5000A225B is a self-contained, broadband solid-state amplifier designed for laboratory applications where instantaneous bandwidth, high gain, and moderate power output are required. A **GAIN** control, which is conveniently located on the unit's front panel, can be used to decrease the amplifier's gain by 20 decibels (dB) or more. Solid state technology is used exclusively to offer significant advantages in reliability and cost. A Model 5000A225B, used with a frequency-swept signal source, will provide 5000 watts of swept power output from .01–100 megahertz (MHz); 4000 watts from 100 MHz to 225 MHz. Typical applications include antenna and component testing, wattmeter calibration, and electromagnetic interference (EMI) susceptibility testing, as well as usage as a driver for frequency multipliers and high-power amplifiers. The Model 5000A225B can be operated locally by using the unit's front panel controls, or remotely by using the unit's IEEE-488, RS-232 interface, USB, or Ethernet interface.

Special features incorporated into the Model 5000A225B include the following:

- **A Control Panel** that allows both local and remote (via a computer interface) control of the amplifier (including adjustment of the amplifier's RF Gain during CW mode operation) and provides graphical displays of the amplifier's Forward and Reflected power levels.
- **RF Output Level Protection**
- **A General Purpose Interface Bus (GPIB)/IEEE-488.2 interface** for remote control of the amplifier's operating functions.
- **RS232 serial communications** including both wire and fiber-optic ports for remote control.
- **USB Communication port** for remote control.
- **Ethernet Communication port** for remote control.
- **Protection** is provided by DC current limiting, over-temperature shut down and RF power limiting.

1.2 SPECIFICATIONS

Refer to the AR RF/Microwave Instrumentation Data Sheet at the end of this section for detailed specifications.

1.3 INSTALLATION

Before proceeding, thoroughly inspect the amplifier for signs of physical damage that may have been incurred during shipment and completely read the following installation and operating instructions, paying special attention to all **CAUTION** notes.

1.3.1 Location

Select an operating location that will permit air to circulate freely around the amplifier's cabinet. The Model 5000A225B utilizes air cooling and should be located where the normal flow of air into or exiting from the unit will not be restricted, diverted, or re-circulated through the unit itself; in particular, the flow of warm air exiting the rear of the amplifier should not be impeded.

Do not position the unit next to a wall or other equipment that would restrict the flow of air into the unit or out of the rear of the unit. The air intake is through the left and right side of the amplifier’s perforated side panels. Ample space—greater than 10 inches (25 cm), should be available on either side for proper cooling.

1.3.2 Primary Power

The Model 5000A225B is designed to operate using AC primary power of 200–240 Volts or 380–415 Alternating Current (VAC), 50–60 Hz, three phase, 19,000 watts maximum.

CAUTION:



Dangerous voltages are present in the Model 5000A225B whenever the unit is plugged into an AC outlet. Always disconnect the unit from the main power line when servicing it. Please note that neither the Keylock or Power switch will completely shut off the unit’s AC power.

Low Voltage Model 10049506: The Model 5000A225B is designed for a primary power input of 200–240 VAC, 50/60Hz, three phase Delta (4-wire) (Wye-compatible). A 65 amp or greater, common-trip circuit breaker should be used to supply power to the 5000A225B low voltage model. Included with the low voltage model is a 15 foot, four-conductor harmonized line cord consisting of three phase wires (brown, black and grey) and a protective GND conductor (green/yellow).

High Voltage Model 10049488: The Model 5000A225B is designed for a primary power input of 380–415 VAC, 50/60Hz, three phase Wye (5-wire). A 40 amp or greater, common-trip circuit breaker should be used to supply power to the 5000A225B high voltage model. Included with the high voltage model is a 15 foot, five-conductor harmonized line cord consisting of three phase wires (brown, black, grey), a neutral conductor (blue) and a protective GND conductor (green/yellow).

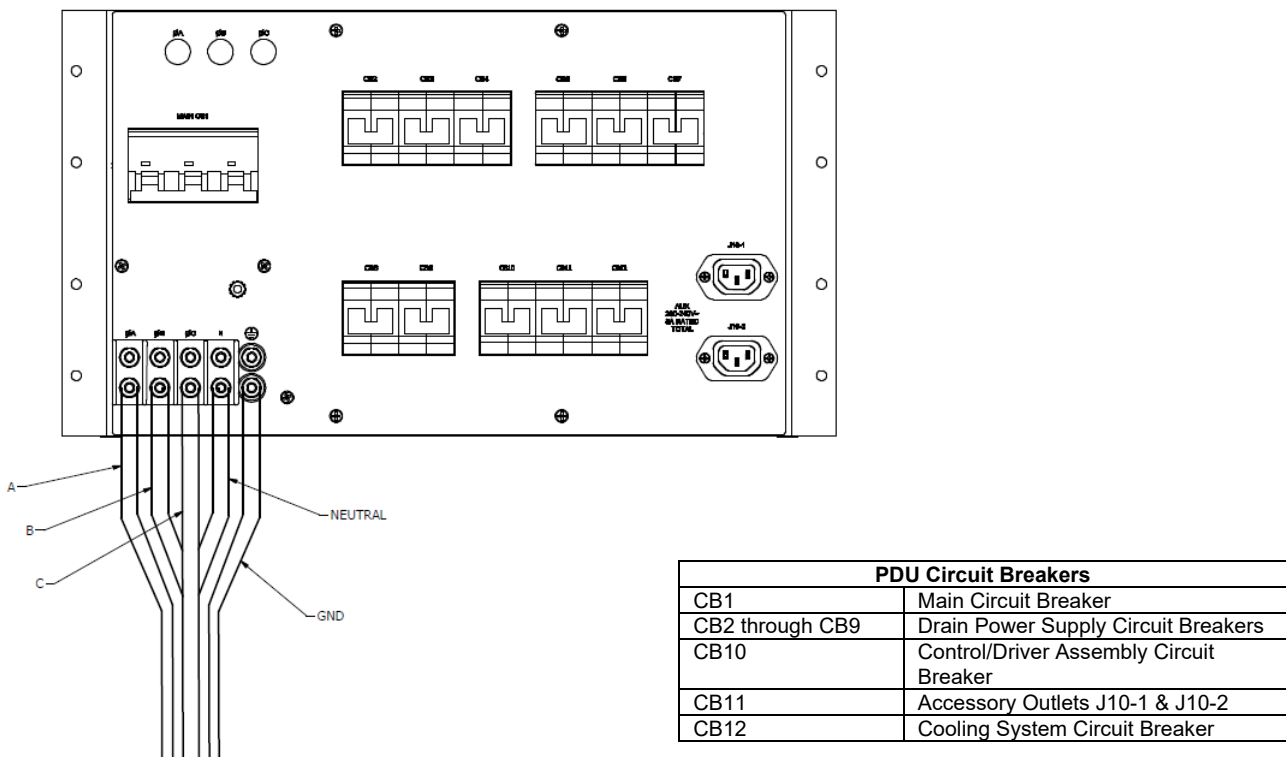

Figure 1-1. 5000A225B AC Line Cord Installation

1.4 RF CONNECTIONS

1.4.1 Amplifier Input Connector

The Type N female RF Input connector for the amplifier can be located on the front or rear of the amplifier. A maximum input signal of 0dBm is recommended to achieve full rated power. The amplifier is protected to +13dBm input without damage or failure.

1.4.2 Amplifier Output Connector

The amplifier output connector is a Type 1-5/8 male located on the rear of the amplifier.



CAUTION:

Placing the amplifier in the Operate mode without a load connected to the output connector is not recommended.

1.4.3 RF Sample Ports

The Forward and Reverse power sample port connectors are Type N female and can be located on the front or rear of the amplifier depending on ordered configuration. Cables and equipment connected to these ports should exhibit resistive 50Ω impedance throughout the band. The sample ports are normally used for interfacing with external power meters. A calibration table that provides a list of external RF power meter offset values is provided. The offset values completely characterize the directional coupler forward and reverse sample port circuit attenuation across the frequency band. This table is provided electronically as part of the test data packet accompanying this manual.



5000A225B

- 5000 Watts CW
- 10kHz–225MHz
- Class A
- Portable
- Full VSWR-tolerant
- CE & RoHS Compliant

Features

The Model 5000A225B is a solid-state, self-contained, broadband amplifier designed for applications where instantaneous bandwidth, high gain and linearity are required. The amplifier is air-cooled using internal self-contained liquid cooling for high performance and reliability. A stylish, contemporary enclosure allows for easy portability.

The Model 5000A225B, when used with a sweep generator, will provide a minimum of 5000 watts of RF power. Included is a front panel gain control which permits the operator to conveniently set the desired output level. The 5000A225B is protected from RF input overdrive by an RF input leveling circuit which controls the RF input level to the RF amplifier first stage when the RF input level is increased above 0dBm. The RF amplifier stages are protected from over-temperature by removing the DC voltage to them if an over-temperature condition occurs due to cooling blockage or fan failure. The Model 5000A225B is equipped with a Digital Control Panel (DCP) which provides both local and remote control

of the amplifier. The DCP uses a color LCD touch screen display to indicate the operate status and fault conditions if an over-temperature or power supply fault has occurred. The unit can be returned to operate when the condition has been cleared.

All amplifier control functions and status indications are available remotely through the included Remotes Package. The Remotes Package includes GPIB/IEEE-488 format, RS-232 hardware and fiber optic, USB, and Ethernet. The bus interface connector is located on the back panel and positive control of local or remote operation is assured by a Local/Remote keyswitch on the front panel of the amplifier. Also included with the Remotes Package is a safety interlock circuit for use with external safety switch interlocks. This circuit prevents the amplifier from going into operate mode unless the external connection is made. A jumper plug is provided for cases where this functionality is not needed.

The export classification for this equipment is EAR99.

5000A225B Typical Output Power

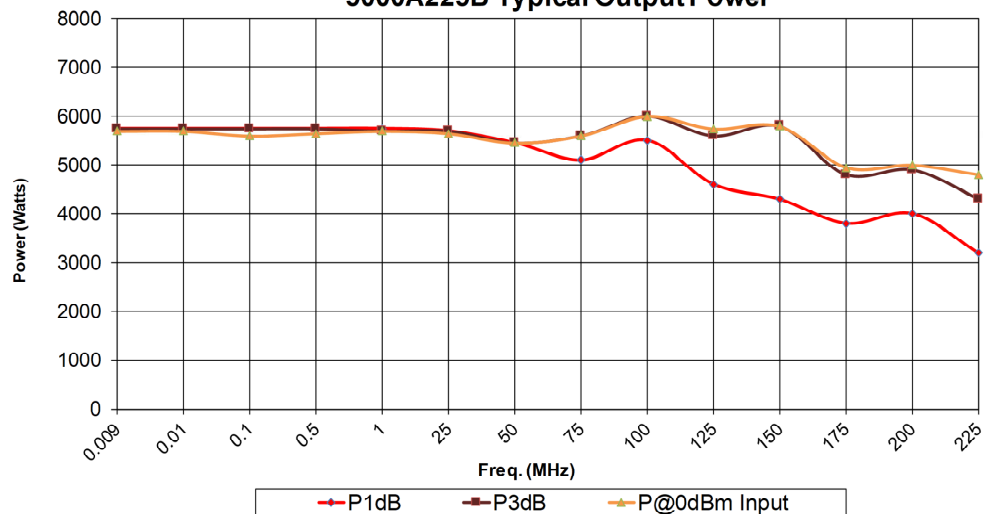

AR RF/Microwave
Instrumentation
160 School House Rd
Souderton, PA 18964
215-723-8181

For an applications engineer call: 800.933.8181

www.arworld.us

ISO 9001 Certified



Specifications

5000A225B

- 5000 Watts CW
- 10kHz–225MHz

RATED OUTPUT POWER:

Typical: 5500 watts, min 5000 watts, .01-100MHz
Typical: 4500 watts, min 4000 watts, 100-225MHz

INPUT FOR RATED OUTPUT: 1.0 mW Max

POWER OUTPUT @ 3dB COMPRESSION:

Typical: 5500 watts, min 5000 watts, .01-100MHz
Typical: 4500 watts, min 4000 watts, 100-200MHz
Typical: 4250 watts, min 3750 watts, 200-225MHz

POWER OUTPUT @ 1dB COMPRESSION:

Typical: 5000 watts, min 4000 watts, .01-100MHz
Typical: 4000 watts, min 3000 watts, 100-200MHz
Typical: 3250 watts, min 2750 watts, 200-225MHz

FLATNESS: ± 1.5 dB typical, ± 2.5 dB maximum

FREQUENCY RESPONSE: 10kHz-225 MHz instantaneously

GAIN (at maximum setting): 67 dB minimum

GAIN ADJUSTMENT (Continuous Range): >20 dB

INPUT IMPEDANCE: 50 ohms, VSWR 2.0:1 maximum

OUTPUT IMPEDANCE: 50 ohms nominal

MISMATCH TOLERANCE: Will operate without damage or oscillation when connected to any load impedance without the aid of foldback circuitry.

MODULATION CAPABILITY: Will faithfully reproduce AM, FM, or Pulse modulation appearing on input signal.

THIRD ORDER INTERCEPT: 77 dBm typical

NOISE FIGURE: 9.5 dB typical

HARMONIC DISTORTION: Minus 30 dBc typical, minus 20 dBc maximum at 3750 watts

SPURIOUS: Minus 70 dBc typical

PRIMARY POWER (User must specify): 200-240 VAC or 380-415 VAC, 3-phase, 50/60Hz, 17 kWatts

CONNECTORS:

RF Input: N female
RF Output: 1-5/8 male, rear
Sample Ports: N female

REMOTES PACKAGE:

IEEE-488: 24-pin female
RS-232: 9-pin subminiature D (female)
Fiber optic: ST Conn Tx and Rx RS-232
USB 2.0: Type B
Ethernet: RJ-45
Safety Interlock: 15-pin subminiature D

COOLING: Forced air, internal self-contained liquid

WEIGHT: 295 kg (650 lbs)

SIZE (W x H x D): 56.1 x 181.6 x 82.4 cm (22.1 x 71.5 x 32.5 in)

ENVIRONMENTAL:

Operating Temperature: 5°C / +40°C
Operating Altitude: Up to 2000M
Shock and vibration: Normal Truck Transport

REGULATORY COMPLIANCE:

EMC EN 61326-1
Safety UL 61010-1
CAN/CSA C22.2 #61010-1
CENELEC EN 61010-1
RoHS DIRECTIVE 2011/65/EU

EXPORT CLASSIFICATION: EAR99

Ordering Options

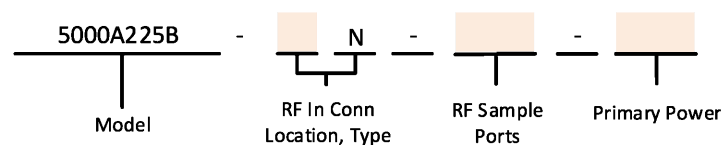

CONNECTOR LOCATION		RF SAMPLE PORTS		PRIMARY POWER	
Front	F	RF Sample Ports Front	SPF	200-240 VAC	LV
Rear	R	RF Sample Ports Rear	SPR	380-415 VAC	HV

Contact your AR RF/Microwave Instrumentation Sales Associate for specific model configuration pricing.

5000A225B

- 5000 Watts CW
- 10kHz-225MHz

Typical Gain @ -20 dBm input

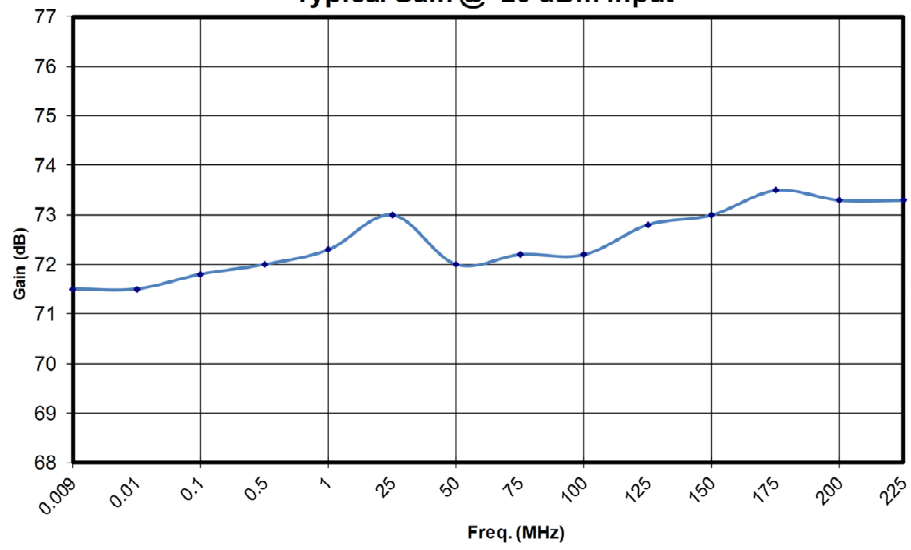

Typical Harmonics @ 3750 watts

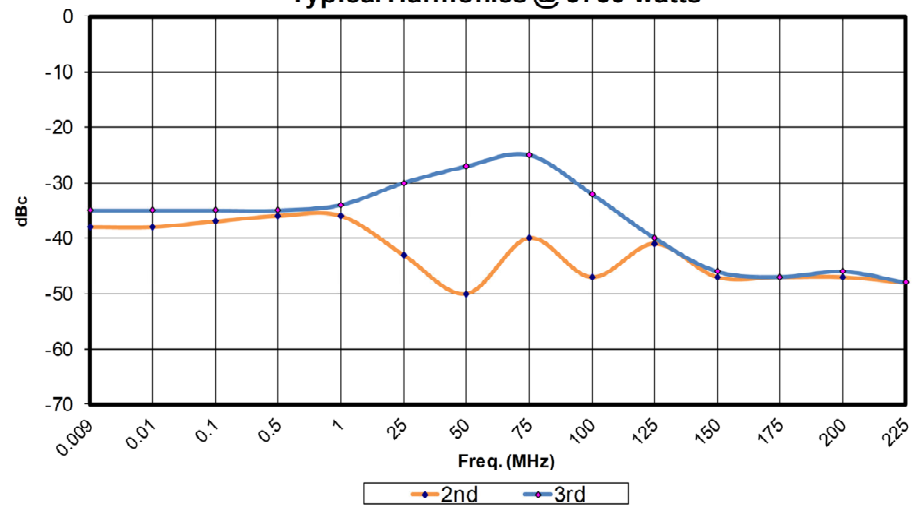

5000A225B

- 5000 Watts CW
- 10kHz-225MHz

Typical Noise Figure vs. Frequency

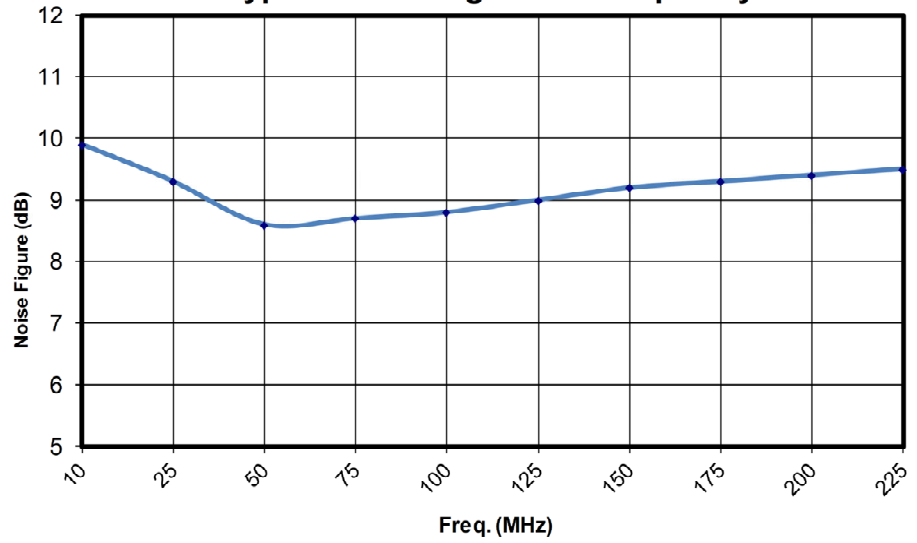

Typical Input VSWR

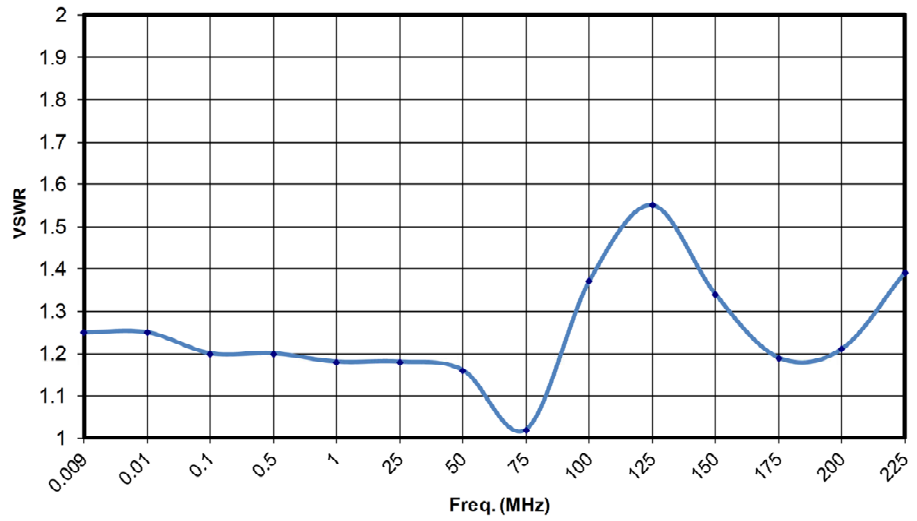

Specifications

5000A225B

- 5000 Watts CW
- 10kHz-225MHz

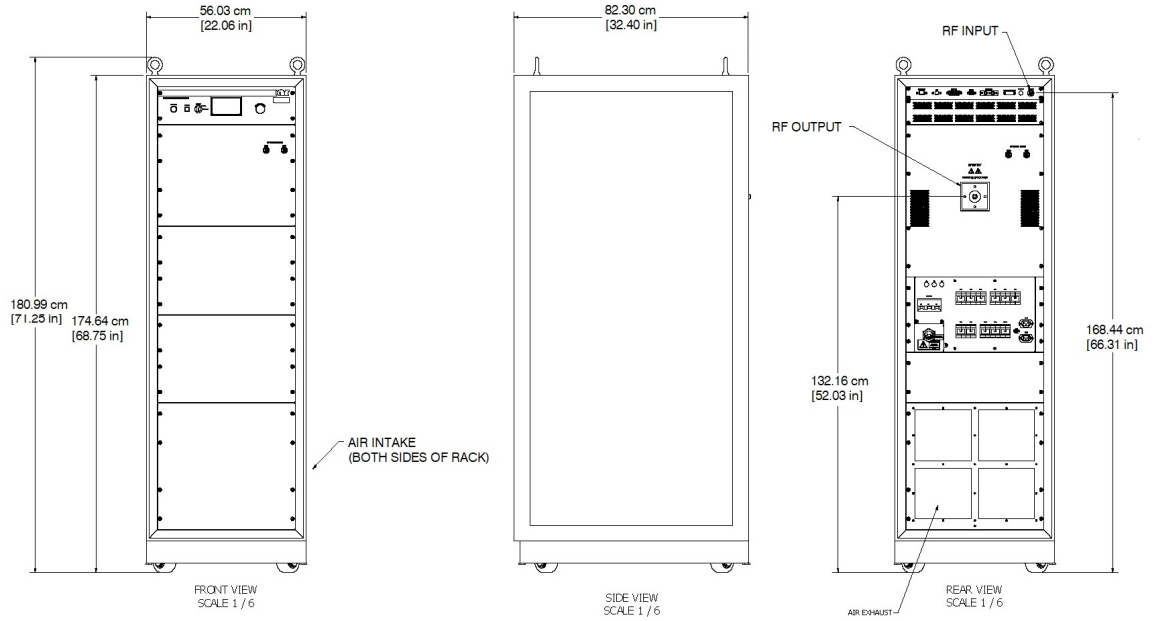

2. OPERATING INSTRUCTIONS

2.1 GENERAL

Operation of the Model 5000A225B broadband amplifier is quite simple. The amplifier's input signal, whether swept or fixed in frequency, is fed into the jack marked **RF INPUT**, and the amplifier's output signal is taken from the jack labeled **RF OUTPUT**. The unit is turned on by activating the front panel **POWER** switch. In the event of a major malfunction, protection is provided by a circuit breaker located on the unit's rear panel.



CAUTION:

The Model 5000A225B amplifier will operate without damage or oscillation with any magnitude and phase of source and load impedance. However, placing the amplifier in the operate mode without a load connected to the output connector is not recommended. It has also been designed to withstand, without damage, RF input power levels up to twenty (20) times its rated input of 1mW. However, signal levels higher than 20mW or transients with high peak voltages can damage the amplifier. Also, accidental connection of the Model 5000A225B's output to its input (either through direct connection or parasitic feedback paths) will cause oscillations that may permanently damage the unit's input transistors

The 5000A225B Amplifier is protected from input overdrive by an automatic level control circuit. The 5000A225B RF power transistors are protected from over temperature by sensing the chassis temperature near the RF output transistors. In the event of a cooling fan failure or an airflow blockage, the DC voltage will be removed from the RF stages.

2.2 CONTROL AND INDICATOR FUNCTIONS

The Model 5000A225B's front panel is shown in Figure 2-1; the unit's rear panel features are detailed in Figure 2-2.

2.2.1 Keylock Switch

The Keylock Switch is provided for protection from unauthorized use or unexpected remote control of the amplifier. The amplifier can only be turned on locally when the Keylock Switch is in the **LOCAL** position. Likewise, the unit can only be turned on or controlled remotely when the Keylock Switch is in the **REMOTE** position. Placing the Keylock Switch in the **INHIBIT** position places the amplifier in the RF Off mode and prohibits any control of the amplifier.

2.2.2 POWER Switch

The momentary **POWER** switch turns the main power to the amplifier on and off. The status of the green light-emitting diode (LED) in the switch indicates whether the amplifier's power is on or off. The main power supply fans are active when power is on. The graphic display is active as long as the main power circuit breaker of the amplifier power entry module is on.

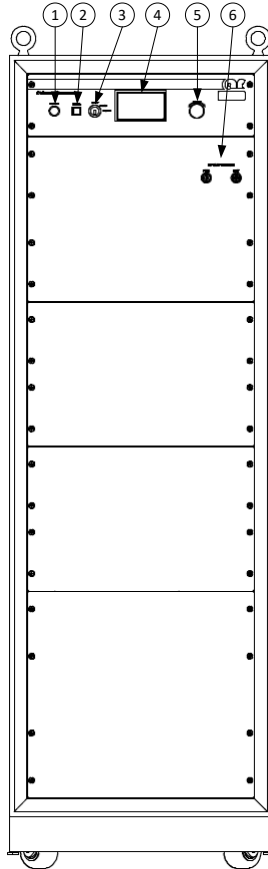

Figure 2-1. Digital Control Panel (DCP) Features

Item	Title	Function
1	RF INPUT	RF Input Connector (front option)
2	POWER	POWER control with indicator LED
3	INHIBIT, LOCAL, REMOTE	Keylock Switch, 3-position; key removal in INHIBIT position only
4	DISPLAY (TOUCH SCREEN)	Numerous parameter values and fault messages, plus manual input control
5	ADJUST	Adjust knob to change selected variables
6	RF SAMPLE PORTS	Forward (left) and Reverse (right) (front option)

2.2.3 Main Power

The Main Power circuit breaker and the Power Inlet are located on the rear panel of the amplifier.

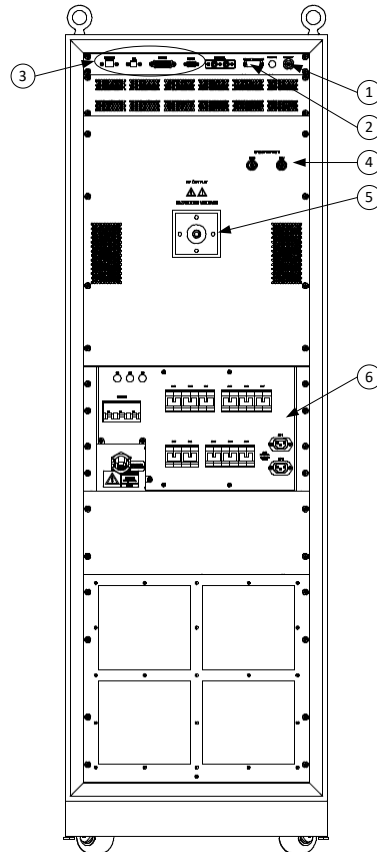

Figure 2-2. Rear Panel Features

Item	Title	Function
1	RF INPUT	RF Input Connector (rear option)
2	SAFETY INTERLOCK	Safety Interlock, 15-pin DIN connector
3	REMOTE CONTROL	GPIO, USB RS-232, F/O and Ethernet remote control connectors
4	RF SAMPLE PORTS	Forward (left) and Reverse (right) (rear option)
5	RF OUTPUT	RF Output Connector
6	PDU	Power Distribution Unit

2.2.4 RF ON/OFF

The RF ON/OFF touch screen button toggles the amplifier from a Standby to an Operate mode. The status of the function is indicated on the display as RF ON or RF OFF. In the RF ON state, RF output is enabled according to control settings and amplifier RF input. Main cooling fans will operate. In the RF OFF state, there will be no RF output.

2.2.5 RESET Function

The RESET function, selected by the touch screen button, will cause the amplifier to attempt to reset. Selecting Reset may clear the fault, depending upon the type of fault that has occurred. If the amplifier is in an over-driven condition, lowering the amplifier's gain or RF input level should enable the function to reset the amplifier.

2.3 DIGITAL CONTROL PANEL (DCP) OPERATIONS

The operations described in this section assume that the user is performing these operations from the amplifier's front panel with the Keylock Switch in the LOCAL position. Remote control using a personal computer is available when the Keylock Switch is set to REMOTE. Refer to Section 2.5.5 for information on remote operation.

Amplifier functions are visually monitored on the front panel display. POWER is controlled by a dedicated push-button switch to the left of the display. The safety Keylock Switch is located to the lower left of the display.

In the center of the digital control panel is the graphic touch display. It is used to provide amplifier status information and a set of menu functions for controlling the amplifier. The menu selections are typically found as software generated buttons on the right side of the display screen. In some cases, these buttons can also be found in other areas of the screen. From the MAIN MENU the user can access the RF ON/OFF button. The RF ON/OFF button causes the power amplifier sections to produce RF output power from the output connector, based on the various settings and the input level to the amplifier.

To the far right is an ADJUST knob. This knob is used to adjust many of the variables shown on the graphic touch display.

The graphic touch display is active and illuminated whenever AC power is supplied to the unit and the main circuit breaker is on.

At the top of the Main Menu screen is a bar graph and numeric value (blue) which is used to indicate whichever user adjustable parameter is selected. These parameters are RF Gain, ALC Threshold Level, ALC Detector Gain, and ALC Response. (Not all adjustments are available on every amplifier.) The Select button from the Main Menu is used to select these parameters.

Below the adjustment value section is an indicator for the RF state and the amplifier mode. The RF state can be changed using the RF On/Off button found in the lower right of the Main Menu.

Below the RF state indicator is the amplifier mode indicator. Possible modes are Manual, Pulse, ALC Internal, and ALC External. (Not all modes are available on every amplifier.) The amplifier mode can be changed using the Mode button from the Main Menu.

Toward the bottom of the display are two bar graphs and two numeric values used to indicate the forward and reflected power (green and red respectively). These indications are developed using a dual-directional coupler located within the amplifier near the RF output port, and should be used as un-calibrated indicators of approximate power level.

General Display Navigation is shown in Figure 2-3, **Touch Display Menu Map**.

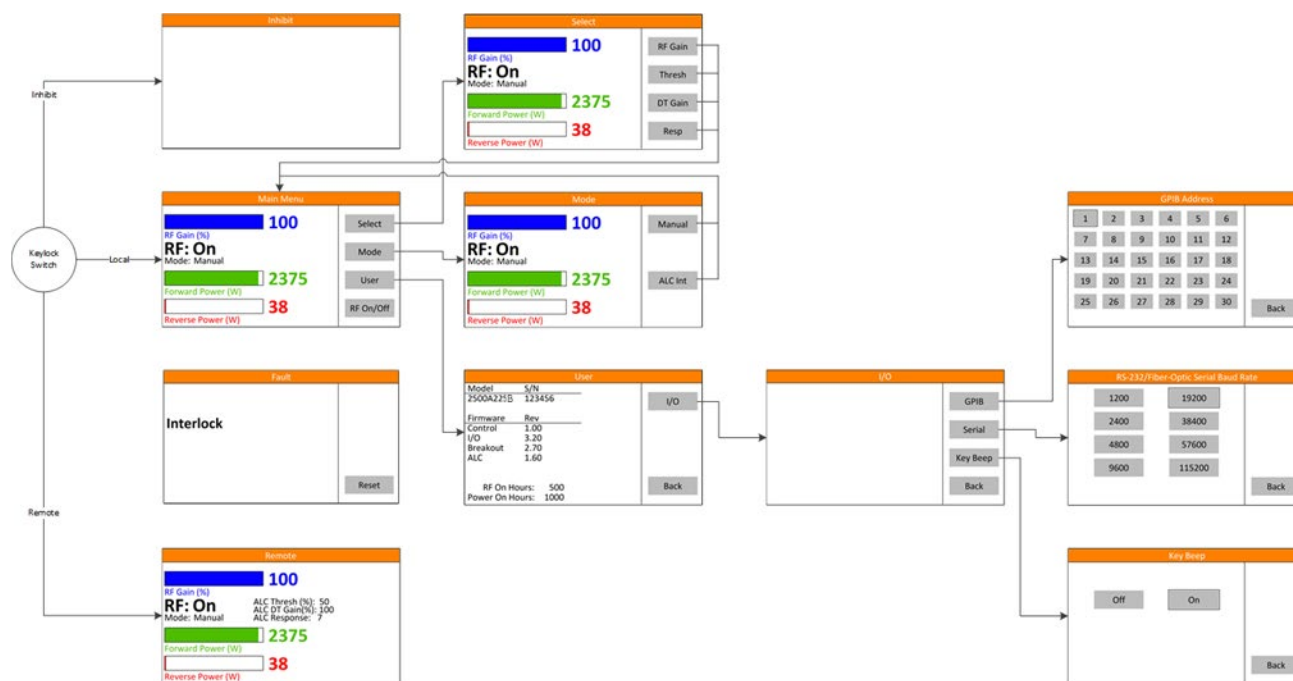

Figure 2-3. Touch Panel Display Menu Map
Values shown on screens are for illustration only.

2.3.1 RF GAIN Control

The RF GAIN control is used to adjust the input attenuator of the preamplifier-leveler module. This control simply adjusts the output power level for a fixed input power level.

To adjust the RF Gain, press the Select button from the Main Menu and then press the RF Gain button in the subsequent menu. Adjust the value using the adjust knob. Please note that the display panel is limited in resolution compared to the control signals, which are generated and sent to the leveler electronics module.

2.4 INPUTS AND OUTPUTS

The input and output connectors described in the following sections are located on the unit’s front or rear panels; refer to the Front and Rear Panel Features drawings (Figure 2-1, Figure 2-2).

2.4.1 RF Input

This Type N connector is the RF input to the amplifier. It should be connected to a RF signal generator or sweep generator.

2.4.2 RF Output

This Type 1-5/8 EIA male connector is the RF output of the amplifier.



CAUTION:

Do not connect or disconnect any loads or cables from the amplifier's RF Output when the amplifier is in the Operate mode. Dangerous voltages that could cause serious injury to the user exist at the RF Output when the amplifier is under power.

2.4.3 IEEE-488, USB, and RS-232 Interfaces

The Model 5000A225B's remote interfaces allow remote control, via a computer, of all amplifier functions (except for the Keylock Switch position) that can be controlled from the front panel. When the amplifier is in the Remote mode (as determined by the position of the Keylock Switch), a special Remote display is shown (see Figure 2-3). Front panel controls are deactivated, except for the Keylock Switch, which can be rotated to LOCAL or INHIBIT in order to prevent remote control commands from being executed.

Refer to Section 2.6 for information on remote operation of the amplifier.

2.4.4 Safety Interlock Connector

Located on the left side of the rear panel, as viewed from the rear, are the remote interface connectors and safety interlock connectors. The 15-pin D-sub miniature female safety interlock connector provides two separate interlock loops. Pins 1 and 8 are used for situations where the amplifier can be left on, but forced into STANDBY mode. This interlock is called Inhibit Interlock. Pins 10 and 14 are used for situations that demand the safest possible condition, with the AC power to all main circuits disconnected. This interlock is called AC Interlock. Both loops must be closed, or jumpered, for normal operation.

2.5 AMPLIFIER OPERATION

2.5.1 Local Operation

1. Connect the input signal to the unit's RF INPUT connector. The input signal level should be 0dBm maximum.
2. Connect the load to the unit's RF OUTPUT connector.
3. Set the REMOTE/LOCAL switch to LOCAL.
4. Check to see that the MAIN POWER switch on the unit's rear panel is set to the 1 (on) position.
5. Press the POWER switch.
6. Place the unit in the Operate mode by pressing the RF On/Off touch screen button.
7. Adjust the amplifier's gain by rotating the ADJUST knob.
8. In the event of a fault, press the RESET touch screen button; if the fault does not clear, refer to Section 4.3 **Troubleshooting** of this manual.

2.6 REMOTE OPERATION

This section describes remote operation of this amplifier using the provided remote communication ports connected to a device such as a personal computer. All ports are active at all times, however only one port may be used at a time. Communicating through two or more ports at one time will cause data collisions and lost commands or queries.

The Keylock switch on the front panel allows the amplifier to be controlled using the remote communications ports, the front panel controls, or neither depending on its position. All remote queries will work in any switch position. All remote commands will only work when the switch is set to REMOTE. When the switch is set to REMOTE all front panel controls are disabled. However, faults can be reset locally by way of the Reset button displayed on the touch screen regardless of Keylock switch position.

2.6.1 IEEE-488 (GPIB) Communication

For IEEE-488 operation, the device address is set using the front panel touch screen. Ensure that each device connected to the IEEE-488 bus is set to a unique address.

Specific IEEE-488 bus commands depend on which software package you are using. To send commands be sure that the amplifier's address is set properly and that the controller has correctly identified the unit as a "listening" device.

When sending commands via the GPIB interface, terminate the command with a Line Feed character, an EOI, or both. The amplifier will ignore characters following the termination.

2.6.1.1 Setting the IEEE-488 (GPIB) Address

The IEEE-488 device address can be set to any number between 1 and 30. This selection is made by navigating to the GPIB address selection screen. To get there from the Main Menu, touch the User menu button followed by the I/O menu button and finally the GPIB menu button. Touching any of the buttons labeled 1 to 30 immediately sets the GPIB address to the corresponding value. A thin black outline indicates the present address selection. When the back button is pushed, the address selection is stored to non-volatile memory. Therefore, if power is lost prior to hitting the back button, any address selection changes will be lost.

2.6.2 RS-232 Communication

The RS-232 port is a serial communications bus. All commands and queries through this port must be terminated with a Line Feed character. When a valid query is received, it is processed and the result is immediately transmitted back over the RS-232 interface. This port is designed to time-out if there is no activity on the bus for more than 5 seconds. At this time the internal buffer is cleared and a **TIMEOUT_ERROR** message followed by a Line Feed character is sent out from this port.

The baud rate for the RS-232 port is user selectable from the RS-232/Fiber-Optic Serial Baud Rate selection screen. To get there from the Main Menu, touch the User menu button followed by the I/O menu button and finally the Serial menu button. A thin black outline indicates the present baud rate selection. When the back button is pushed, the baud rate selection is stored to non-volatile memory. Therefore, if power is lost prior to hitting the back button, any baud rate selection changes will be lost.

NOTE: This baud rate setting is shared by both the RS-232 port and the Fiber-Optic serial port.

The RS-232 port is setup as a Data Circuit-terminating Equipment (DCE) port. When connecting to a Personal Computer (PC) a straight one-to-one cable should be used. A null modem is NOT needed. The settings and pin-out diagram for this port can be found below.

Table 2-1. RS-232 Port Settings

Word Length	8 bits
Stop Bits:	1
Baud Rate:	User selectable (default is 19200)
Parity:	None
HW Handshake:	None

Table 2-2. RS-232 (DCE) Port Pin-out Diagram DB-9 Female

Pin 1	DCD
Pin 2	TD
Pin 3	RD
Pin 4	DTR
Pin 5	GND
Pin 6	DSR
Pin 7	CTS
Pin 8	RTS
Pin 9	Unused

2.6.3 Fiber-Optic Communication

The Fiber-Optic port is a serial communications bus. All commands and queries through this port must be terminated with a Line Feed character. When a valid query is received, it is processed and the result is immediately transmitted back over the Fiber-Optic interface. This port is designed to time-out if there is no activity on the bus for more than 5 seconds. At this time the internal buffer is cleared and a **TIMEOUT_ERROR** message followed by a Line Feed is sent out from this port.

The baud rate for the Fiber-Optic Serial port is user selectable from the RS-232/Fiber-Optic Serial Baud Rate selection screen. To get there from the Main Menu, touch the User menu button followed by the I/O menu button and finally the Serial menu button. A thin black outline indicates the present baud rate selection. When the back button is pushed, the baud rate selection is stored to non-volatile memory. Therefore, if power is lost prior to hitting the back button, any baud rate selection changes will be lost.

NOTE: This baud rate setting is shared by both the Fiber-Optic serial port and the RS-232 port.

The Fiber-Optic port provides the user with the ability to optically isolate the controlling PC from the amplifier. This can be useful in an environment where RF/Microwave energy could be coupled onto a connection to one of the “wired” communications ports and fed back to the controlling PC.

Both optical connections (TX and RX) are optimized to work with light at a wavelength of 820nm. For more detailed specifications on this port, consult the Avago HFBR series datasheet found at www.avagotech.com.

A glass, multi-mode, fiber-optic cable of 200um is recommended, however fiber-optic cable as small as 50um can be used. The connector type for this port is ST.

This port can be used in conjunction with either an AR model IF7000 RS-232 to Fiber-Optic Interface (1200 to 9600 baud only) or an AR model IF7001 USB to Fiber-Optic Interface (19200 baud only). Note that these devices use SMA connectors so a fiber-optic cable is needed with ST connectors on one end and SMA connectors on the other. This cable can be obtained from a fiber-optic cable distributor such as Fiber Instrument Sales (FIS). Their web-site can be found at www.fiberinstrumentsales.com. An example cable that will work for this connection is FIS Part Number D615M7FIS. The 7 in the part number refers to the length of the cable. In this case the length is 7 meters.

Table 2-3. Fiber-Optic Serial Port Settings

Word Length	8 bits
Stop Bits:	1
Baud Rate:	User selectable (default is 19200)
Parity:	None
HW Handshake:	None

2.6.4 USB Communication

The USB port is a USB 2.0 port. It also complies with the USB Test and Measurement Class (USBTMC) Standard. Communications with this port requires the host computer to have a USBTMC driver available. All commands and queries through this port must be terminated with a Line Feed character.

The cable required to make this connection is a USB 2.0 A-B peripheral device cable. The cable can be no longer than 5 meters. If a longer distance is required a USB hub must be used. A cable carrying the official USB logo is recommended.

If this PC has National Instruments LabView installed it will have a USBTMC driver that will work with this port. This driver will allow the device to be easily controlled using National Instruments Measurement and Automation Explorer or LabView. It should be noted that the USBTMC driver provided by National Instruments is a Virtual Instrument Software Architecture (VISA) driver which can be used with other programming languages besides LabView. For more information on this please consult the National Instruments Website found at www.ni.com.

NOTE: All firmware updates are done through the USB port.

2.6.5 Ethernet Communication

The Ethernet port allows remote control through a Transmission Control Protocol (TCP) data channel. All commands and queries through this port must be terminated with a Line Feed character.

By default, this port is setup to work on a network with a Dynamic Host Configuration Protocol (DHCP) server. Upon connection, an Internet Protocol (IP) address is assigned based on the internal Media Access Control (MAC) address. The MAC address is printed on a label located near the Ethernet port.

If the connected network does not have DHCP enabled, then the device can be assigned an IP address by the user. To do this, download the utility called DeviceInstaller™ from www.Lantronix.com. For assistance using this utility please consult the utilities embedded help file.

The DeviceInstaller™ utility will scan the network and find all connected Lantronix Ethernet devices. This list of found devices will include any connected AR Ethernet devices. By selecting one of the connected devices from the list, its IP address and subnet mask can be changed along with a number of other settings. One should use caution in adjusting any settings he/she is unfamiliar with as doing so may cause the port to become unresponsive. By default the port for the TCP data channel is 10001.

- * DHCP is a protocol used to assign a dynamic IP address to a device. Network server software will assign an available IP address to a device when it is connected and powered on. Different IP addresses may be assigned at different times.

2.6.6 Remote Commands

- If a command or query is unrecognized it is echoed back out the port it came in on.
- All commands and queries are terminated with a Line Feed character.
- A Line Feed character is indicated by <LF> in subsequent command and query definitions.
- All queries can be sent when the Keylock switch is in the INHIBIT, LOCAL, or REMOTE position.
- All commands can only be sent when the Keylock switch is in the REMOTE position.
- All spaces in command and query definitions are indicated by <space>.
- If a query is recognized, its associated response is echoed out the port it came in on.

A **COMMUNICATIONS_ERROR**<LF> can occur if the time between commands or queries is too short, or the internal RS-485 link between the IO Board assembly and the Multipurpose Board (MPB) assembly is broken.

The development of application programs requires an understanding of the operation of the amplifier as well as the intended application.

An application program on the computer/controller should issue only one character string (command or query) at a time. After each functional command is issued, the amplifier's status should be checked to ensure that the command has been properly executed. The application program should allow sufficient time for the function to be completed before checking the status.

The application program should facilitate the checking of the status just prior to issuing a command, since the status could have been changed by a fault condition or by operator actions.

Variables represented by wild card characters i.e. x, y, z etc. do not indicate or delimit the number of characters actually specified.

Table 2-4. Relationship between DCP Controls and Remote Communication

AC Power and Circuit Breaker		Power		Keylock Switch			Remote Communication	
On	Off	On	Off	INHIBIT	LOCAL	REMOTE	Command	Query
	√						X	X
√			√			√	√	√
√		√				√	√	√
√		√			√		X	√
√			√		√		X	√
√			√	√			X	√

X = No, √ = Yes

2.6.6.1 Power On/Off

This command controls the power on/off state of the amplifier.

Syntax: **POWER:x**

Parameters: State(x):
OFF = power off
ON = power on

Response Format: None (No query for this command)

Example: To turn the power on, send the following command:

POWER:ON<LF>

To turn the power off, send the following command:

POWER:OFF<LF>

2.6.6.2 RF On/Off

This command controls the RF on/off state of the amplifier.

Syntax: **RF:x**

Parameters: State(x):
OFF = power off
ON = power on

Response Format: None (No query for this command)

Example: To turn the RF on, send the following command:

RF:ON<LF>

To turn the RF off, send the following command:

RF:OFF<LF>

2.6.6.3 Reset Faults

This will clear all faults, if possible.

Syntax: **RESET**

Parameters: None

Response Format: None (No query for this command)

Example: To clear any faults, send the following command:

RESET<LF>

2.6.6.4 Mode Select

This command sets the ALC mode of the amplifier.

Syntax: **MODE:x**

Parameters: Mode(x):

MANUAL = Set to Manual mode

PULSE = Set to Pulse mode*

ALC<space>INT = Set to ALC Internal mode

ALC<space>EXT = Set to ALC External mode*

Response Format: None (No query for this command)

Example: To set the ALC mode to Manual mode, send the following command:

MODE:MANUAL<LF>

**Not available on all amplifier models*

2.6.6.5 Level Adjust

This command sets the RF Gain, ALC Detector Gain, ALC Threshold, and ALC Response Time.

Syntax: **LEVEL:xy**

Parameters: Parameter(x):

GAIN = RF Gain

DET = ALC Detector Gain

THR = ALC Threshold

RESP = ALC Response Time

Value(y):

For RF Gain, ALC Detector Gain, and ALC Threshold:

0 = Minimum

100 = Maximum

For ALC Response Time:

0 = Minimum

7 = Maximum

Response Time Setting	Time (mS)
0	1
1	5
2	10
3	30
4	100
5	1000
6	3000
7	3000

Response Format: None (No query for this command)

Example: To set the RF Gain to minimum, send the following command:
LEVEL:GAIN0<LF>
To set the RF Gain to 50%, send the following command:
LEVEL:GAIN50<LF>
To set the ALC Response Time to max, send the following command:
LEVEL:RESP7<LF>

2.6.6.6 Identity

Query to identify the amplifier.

Syntax: ***IDN?**

Parameters: None
Query only (always requires a ? character)

Response Format: **f,m,n,<LF>**
Where:
f = manufacturer
m = model designation
n = firmware revision

Example: To get the identity of the amplifier, send the following command:
***IDN?<LF>**

Response: **AR-RF/MICROWAVE-INST,MODEL,1.0<LF>**

2.6.6.7 IO Board Firmware Revision

Query to get the firmware revision of the I/O Board.

Syntax: ***IOB?**

Parameters: None
Query only (always requires a ? character)

Response Format: **INTERFACE_BOARD_SW_REVx<LF>**
Where:
x = firmware revision

Example: To get the firmware rev. of the I/O Board, send the following command:
***IOB?<LF>**

Response: **INTERFACE_BOARD_SW_REV3.00<LF>**

2.6.6.8 Machine State

This query reads the RF gain, detector gain, ALC threshold, and ALC response time of the amplifier.

Syntax: **MSB?**

Parameters: None

Query only (always requires a ? character)

Response Format: **RF<space>GAIN=x,
DT<space>GAIN=x,
THRES=x,
RESP=y<LF>**

Value(x):

For RF Gain, Detector Gain, and ALC Threshold:

0 = Minimum

100 = Maximum

Value(y):

For Response Time:

0 = Minimum

7 = Maximum

Response Time Setting	Time (mS)
0	1
1	5
2	10
3	30
4	100
5	1000
6	3000
7	3000

Example: To get the machine state, send the following command:

MSB?<LF>

Response: **RF<space>GAIN=100,DT<space>GAIN= 50,THRES= 75,RESP=1 <LF>**

(RF gain is 100%, Detector Gain is 50%, ALC Threshold is 75%, and ALC Response Time is set to 5mS)

2.6.6.9 State

Query to find the state of the amplifier.

Syntax: **STATE?**

Parameters: None

Response Format: **STATE=<space>xyza<LF>**

Where:

x, **y**, **z**, and **a** are each an ASCII character representing a hexadecimal character. They can be 0 to 9 or A to F.

Each hexadecimal character represents a 4-bit binary number. This 4-bit number is a bit pattern which contains information about the state of the amplifier. The definitions of these bit positions can be found in the table below.

NOTE: Bits labeled NOT USED may be read as a bit state of 1 or 0

	BIT POSITION	BIT DESCRIPTION	BIT STATE		NOTES:
			0	1	
x	0	PULSE STATUS	OFF	PULSE	
	1	(NOT USED)			
	2	(NOT USED)			
	3	REMOTE CONTROL	DISABLED	ENABLED	Response to key-switch position
y	0	POWER STATUS	OFF	POWER ON	
	1	STANDBY STATUS	OFF	STANDBY	Also known as RF OFF
	2	OPERATE STATUS	OFF	OPERATE	Also known as RF ON
	3	FAULT STATUS	OFF	FAULT EXISTS	
z	0	KEYLOCK INHIBIT	OFF	INHIBITED	Response to key-switch position
	1	(NOT USED)			
	2	(NOT USED)			
	3	(NOT USED)			
a	0	MODE MANUAL	DISABLED	ENABLED	
	1	MODE PULSE	DISABLED	ENABLED	
	2	MODE ALC INTERNAL	DISABLED	ENABLED	
	3	MODE ALC EXTERNAL	DISABLED	ENABLED	

Example: To read the state, send the following query.

STATE?<LF>

Response: **STATE=<space>8301<LF>**
(Remote Mode, Power On, RF OFF, and Manual Mode)

2.6.6.10 Forward Power

Query to get the forward power.

Syntax: **FPOW?**

Parameters: None

Response Format: **FPOW=x<LF>**

Where:

x = 0 to 99999

Values are corrected and linearized. They can be up to five digits in length. Leading zeros are read as spaces. Units are Watts.

Example: To find out the forward power, send the following query.

FPOW?<LF>

Response: **FPOW=<space><space><space>54<LF>** *(54 Watts of forward power)*

2.6.6.11 Reverse Power

Query to get the reverse power.

Syntax: **RPOW?**

Parameters: None

Response Format: **RPOW=x<LF>**

Where:

x = 0 to 99999

Values are corrected and linearized. They can be up to five digits in length. Leading zeros are read as spaces. Units are Watts.

Example: To find out the reverse power, send the following query.

RPOW?<LF>

Response: **RPOW=<space><space><space><space>9<LF>** *(9 Watts of reverse power)*

2.6.6.12 RF Gain

Query to get the RF gain.

Syntax: **RFG?**

Parameters: None

Response Format: **RFG=<space>x<LF>**

Where:

x = 0000 to 0100

Example: To find out the RF gain of the amplifier, send the following query:

RFG?<LF>

Response: **RFG=<space>0075<LF>** (75% Gain)

2.6.6.13 Faults (5000A225B)

Query to find the faults that have occurred with the amplifier.

Syntax: **FSTA?**

Parameters: None

Response Format: **FSTA=<space>xxxx**

Where:

xxxx = 0000 to 0408 (Hexadecimal)

Fault Details			
Hex	Dec	Fault Text (<15 Characters)	Description
00	0		No Fault
0x0001	1	Interlock	Interlock
0x0002	2	AC Interlock	AC Interlock
0x0019	25	485 Error	RS-485 Comm Bus Error
0x001a	26	ALC	ALC at max attenuation
0x001b	27	CDU Level	Low Coolant Level
0x001c	28	CDU Flow A	Low Coolant Flow, A
0x001d	29	CDU Flow B	Low Coolant Flow, B
0x0020	32	PDU PS1	Pwr Supply Failure: PDU, PS1
0x0021	33	Driver PS2	Pwr Supply Failure: Driver PS2
0x0022	34	PS1 Rack A	Pwr Supply Failure: PS1 Rack, A
0x0023	35	PS1 Rack B	Pwr Supply Failure: PS1 Rack, B
0x0024	36	PS1 Rack C	Pwr Supply Failure: PS1 Rack, C
0x0025	37	PS1 Rack D	Pwr Supply Failure: PS1 Rack, D
0x0026	38	PS2 Rack A	Pwr Supply Failure: PS2 Rack, A
0x0027	39	PS2 Rack B	Pwr Supply Failure: PS2 Rack, B
0x0028	40	PS2 Rack C	Pwr Supply Failure: PS2 Rack, C
0x0029	41	PS2 Rack D	Pwr Supply Failure: PS2 Rack, D
0x0200	512	Drv Amp A2	Amplifier Fault, Driver Module

Fault Details			
Hex	Dec	Fault Text (<i><15 Characters</i>)	Description
0x0201	513	Amp A1	Amplifier Fault, Final A1 Module
0x0202	514	Amp A2	Amplifier Fault, Final A2 Module
0x0203	515	Amp A3	Amplifier Fault, Final A3 Module
0x0204	516	Amp A4	Amplifier Fault, Final A4 Module
0x0205	517	Amp A5	Amplifier Fault, Final A5 Module
0x0206	518	Amp A6	Amplifier Fault, Final A6 Module
0x0207	519	Amp A7	Amplifier Fault, Final A7 Module
0x0208	520	Amp A8	Amplifier Fault, Final A8 Module
0x0209	521	Amp A9	Amplifier Fault, Final A9 Module
0x020a	522	Amp A10	Amplifier Fault, Final A10 Module
0x020b	523	Amp A11	Amplifier Fault, Final A11 Module
0x020c	524	Amp A12	Amplifier Fault, Final A12 Module
0x020d	525	Amp A13	Amplifier Fault, Final A13 Module
0x020e	526	Amp A14	Amplifier Fault, Final A14 Module
0x020f	527	Amp A15	Amplifier Fault, Final A15 Module
0x0210	528	Amp A16	Amplifier Fault, Final A16 Module
0x0400	1024	Drv Therm A2	Thermal Fault, Driver Module
0x0401	1025	Thermal A1	Thermal Fault, Final A1 Module
0x0402	1026	Thermal A2	Thermal Fault, Final A2 Module
0x0403	1027	Thermal A3	Thermal Fault, Final A3 Module
0x0404	1028	Thermal A4	Thermal Fault, Final A4 Module
0x0405	1029	Thermal A5	Thermal Fault, Final A5 Module
0x0406	1030	Thermal A6	Thermal Fault, Final A6 Module
0x0407	1031	Thermal A7	Thermal Fault, Final A7 Module
0x0408	1032	Thermal A8	Thermal Fault, Final A8 Module
0x0409	1033	Thermal A9	Thermal Fault, Final A9 Module
0x040a	1034	Thermal A10	Thermal Fault, Final A10 Module
0x040b	1035	Thermal A11	Thermal Fault, Final A11 Module
0x040c	1036	Thermal A12	Thermal Fault, Final A12 Module
0x040d	1037	Thermal A13	Thermal Fault, Final A13 Module
0x040e	1038	Thermal A14	Thermal Fault, Final A14 Module
0x040f	1039	Thermal A15	Thermal Fault, Final A15 Module
0x0410	1040	Thermal A16	Thermal Fault, Final A16 Module

Example: To find out what faults have occurred, send the following query. **FSTA?<LF>**

Response: **FSTA= 0001<LF>** (*Interlock Fault*)

2.6.6.14 Operating Hours (RF On)

Query to get the RF On operating hours.

Syntax: **OH?**

Parameters: None

Response Format: **OH=x<LF>**

Where:

x = 0 to 100000

Units are Hours. Values can be up to six digits in length. Leading zeros are read as spaces.

Example: To find out the RF On operating hours, send the following query.

OH?<LF>

Response: **OH=<space><space><space><space>37<LF>**
(The system has spent 37 Hours in an RF On state)

2.6.6.15 Operating Hours (Power On)

Query to get the Power On operating hours.

Syntax: **OHP?**

Parameters: None

Response Format: **OHP=x<LF>**

Where:

x = 0 to 100000

Units are Hours. Values can be up to six digits in length. Leading zeros are read as spaces.

Example: To find out the Power On operating hours, send the following query.

OHP?<LF>

Response: **OHP=<space><space><space>428<LF>**
(The system has spent 428 Hours in a Power On state)

2.6.6.16 AC Power-On Defaults

Default settings that are applied at AC mains power-on can be changed by adding the following prefix to select commands.

Syntax: **DEFAULT:**

Compatible commands:

Level Adjust

LEVEL:GAIN	
LEVEL:DET	(Not available on all models)
LEVEL:THR	(Not available on all models)
LEVEL:RESP	(Not available on all models)

Mode Select

MODE:MANUAL	(Not available on all models)
MODE:PULSE	(Not available on all models)
MODE:ALC<space>INT	(Not available on all models)
MODE:ALC<space>EXT	(Not available on all models)

NOTES:

1. Use the command **DEFAULT:FACTORY** to reset all applicable settings back to their factory defaults.
2. All applicable defaults can be queried, except **DEFAULT:FACTORY**, by adding a ? character in place of the setting parameter.
3. If the ALC Lockout Feature (not available on all models) is engaged, the default ALC values set with this command will not be used.

Example 1: To set the default RF Gain to 75%, send the following command:

DEFAULT:LEVEL:GAIN75<LF>

Example 2: To query the default RF Gain setting, send the following command:

DEFAULT:LEVEL:GAIN?<LF>

Response: **DEFAULT:LEVEL:GAIN75<LF>**

Example 3: To set the default mode to manual, send the following command:

DEFAULT:MODE:MANUAL<LF>

3. THEORY OF OPERATION

3.1 INTRODUCTION

The Model 5000A225B RF amplifier consists of a .01-225 MHz RF amplifier assembly. The RF amplifier assembly consists of a Pre-Amplifier, a driver amplifier module, and a four-way splitter that feeds (4) four-way splitters to drive (16) final amplifier modules. These 16 final amplifier modules are combined through (4) four-way combiners, and a final four-way combiner to yield a combined power of 5000 watts or more.

The power supply section consists of a power distribution unit (PDU), driver assembly, and eight +50V power supplies.

The control system consists of a Control/Fault Board, an Interface Board and remote interfaces for IEEE-488, RS-232, USB, and Ethernet.

3.2 RF AMPLIFIER OPERATION

3.2.1 A1 Pre-Amplifier Assembly

The Pre-Amplifier Assembly consists of two sub-assemblies: the A1 Pre-Amplifier Assembly and the A2 2W Amplifier Assembly.

3.2.1.1 A1 Pre-Amplifier Assembly

The Pre-Amplifier PWB Assembly consists of a variable attenuator circuit (U5), a gain stage (U10), a resistive splitter (R21, R22, R25), and associated control circuitry. The overall gain of the pre-amplifier assembly is approximately 32 dB at minimum attenuation. The power detector (U11) is used to sense the input RF power and it increases the attenuation of the variable attenuator circuit if an input overdrive condition is detected.

3.2.1.2 A2 2W Amplifier Assembly

The 2W Amplifier Assembly has two gain stages (U1 and Q1) that have a combined gain of approximately 30 dB. The output RF power is greater than 1W at the 1 dB compression point

3.2.2 A2 125W 400MHz Module Assembly

The 125W Module Assembly consists of RF matching circuits, an RF transistor (Q1), a bias control circuit, and a fault detection circuit.

The RF input is fed to a 4:1 balun transformer composed of T1 and T2. The output signal of the 4:1 transformer is connected to the gates of Q1. The drains of Q1 are connected to a 4:1 balun transformer composed of T3 and T4. Q1 has approximately 34 VDC applied to both drains at a total current of 8.5A. The RF stage has approximately 21 dB of gain and an output compression point of 90W or greater.

The current through Q1 is monitored by U1. The output of U1 is fed to an op amp (U3) which has a reference voltage on the non-inverting input. U3 compares the output of U1 to the reference voltage and generates an error signal. This error signal varies the gate voltages of Q1 which in turn controls Q1's current draw.

U5 is a comparator that monitors the output of U1 and generates a fault signal if the drain current varies outside normal operating conditions. It also monitors the module temperature via a thermistor (R31) and generates a fault signal if the module heatsink exceeds approximately 80°C.

3.2.3 A19 Four-Way Splitter

The Four-Way Splitter is a broadband splitter. The input signal is split into four equal-amplitude, equal-phase signals. The amplitude of each signal is 6-6.5dB below the input signal when all outputs are terminated into 50Ω loads.

3.2.4 A20-A23 Four-Way Splitter

The Four-Way Splitter is a 180° broadband splitter. The input signal is split into four equal-amplitude signals. The amplitude of each signal is 6-6.5dB below the input signal when all outputs are terminated into 50Ω loads.

3.2.5 A1-A16 Final Module Assembly

The Final Module Assembly consists of RF matching circuits, an RF transistor (Q1), a bias control circuit, and a fault detection circuit.

The RF input is fed to a 4:1 balun transformer composed of T1 and T2. The output signal of the 4:1 transformer is connected to the gates of Q1. The drains of Q1 are connected to a 4:1 balun transformer composed of T3 and T4. Q1 has approximately 50 VDC applied to both drains at a total current of 18A. The RF stage has approximately 19 dB of gain and an output compression point of 250W or greater.

The current through Q1 is monitored by U1. The output of U1 is fed to an op amp (U3) which has a reference voltage on the non-inverting input. U3 compares the output of U1 to the reference voltage and generates an error signal. This error signal varies the gate voltages of Q1 which in turn controls Q1's current draw.

U5 is a comparator that monitors the output of U1 and generates a fault signal if the drain current varies outside normal operating conditions. It also monitors the module temperature via a thermistor (R31) and generates a fault signal if the module heatsink exceeds approximately 80°C

3.2.6 A25-A27 Four-Way Combiner

The Four-Way Combiner operates in zero-degree configuration with a broadband range of .01-225 MHz. The combiner is designed to tolerate loss of input signals at full power.

3.2.7 A28 Four-Way Combiner

The Four-Way Combiner operates in 180-degree configuration with a broadband range of .01-225 MHz. The combiner is designed to tolerate loss of input signals at full power.

3.2.8 A29 Bi-Directional Coupler

The A15 Bi-Directional Coupler takes a sampling of the forward and reverse RF output signal for use in the automatic level control and display circuitry. The RF coupling of the forward and reverse coupled ports is approximately 63 dB.

3.2.9 A3 Detector

The A3 Detector converts the RF signals from the bi-directional coupler to a DC voltage for use in the automatic leveling, sample ports, and display circuitry.

3.3 POWER SUPPLIES

The Model 5000A225B contains eleven switching power supplies. The input voltage range to the power supply is 200–240 VAC, 50/60Hz. The AC input power is approximately 17kWatts.

PS1, located in the driver assembly, is a multiple output supply. PS1 has a +5V, standby supply for the A5 control panel, the A1 remote interface board used for the remote interfaces, the -15V supplied to the A1 preamp, the A2 driver module and the A1–A16 final modules. The +15V is supplied to the A1 through A16 final modules, the A2 dual detector assembly, K1 relay and the A4 interlock isolation assembly.

PS2, also located in the driver assembly, supplies +40V to A1 driver module and the A8 regulator assembly.

PS1, located in the power distribution unit (PDU) supplies +24 VDC to the cooling distribution unit (CDU) for operation of the pump, level and flow sensors, and heat exchanger fans. PS1 also powers the A28 combiner, and A19 splitter fans as well as the final module assembly fans B1 through B4.

The PS1 rack encompasses PS1-A through PS1-D, 2500W, 1U power supplies which supply +50 V to the A5 through A8 final modules and A13 through A16 final modules.

The PS2 rack encompasses PS2-A through PS2-D, 2500W, 1U power supplies which supply +50 V to the A1 through A4 final modules and A9 through A12 final modules.

Primary AC circuit protection is provided by the circuit breaker in the power distribution unit (PDU).

3.4 CONTROL SYSTEM

3.4.1 A5 Control/Fault Board

The A5 Control/Fault board consists of one 16-bit microcontrollers and several other ICs that monitor and indicate the status of the amplifier. Power is supplied using only a single 5-volt power supply. The board offers the following:

Feature	Quantity
Open drain outputs	4
Digital outputs	6
Digital inputs (5-volt tolerant)	24
Analog outputs	2
2-channel encoder input	1
Inputs for a keypad	6
Display connectors	1
Serial communication jacks	2

3.4.2 A1 Interface Board

The A1 Interface board connects the remote control ports to the A2 controller.

3.4.3 A4 ALC

The A4 Level Control Assembly performs the following functions:

- Provides automatic level control of the amplifier's output when placed in ALC mode.
- Limits RF input level to the amplifier when forward or reflected power levels exceed specified limits.
- Drives forward and reflective indicators on the display panel.

3.5 SAMPLE PORTS

The signals appearing at the sample ports produce a level of approximately -1dBm at 5000W. Both forward and reverse signals have the same scaling at this point. The sample ports are measured during final alignment of the amplifier and a correction table is provided with enough measured points to adequately characterize the sample ports across the full bandwidth of the amplifier. When used with a power meter, sample ports are intended to be a general guide to the forward and reverse power being produced. If more accuracy or calibration is required an external directional coupler is recommended.

4. MAINTENANCE

4.1 GENERAL MAINTENANCE INFORMATION

Because it is a relatively simple instrument, the Model 5000A225B should require very little maintenance. It is built with solid state devices and printed wiring boards (PWBs) that should ensure long, trouble-free life. Should trouble occur, special care must be taken when servicing the unit to avoid damaging the solid state devices and PWB's.

Since the amplifier's components are soldered in place, substitution of components should not be resorted to unless there is some indication that they are faulty. In addition, care must be taken not to short voltages across the amplifier when troubleshooting, because small bias changes may damage the amplifier due to excessive dissipation or transients.

Components used in AR RF/Microwave Instrumentation instruments are conservatively operated to provide maximum instrument reliability. In spite of this, parts may fail. Usually, the instrument must be immediately repaired with a minimum of down time. A systematic approach can greatly simplify and thereby speed up repairs. The Model 5000A225B incorporates fault control and detection circuits, including display panel indications that can expedite troubleshooting of the unit. For a description of how these indications can be used to assist in troubleshooting the unit, please see Section 4.3.

Shipping instructions are as follows. To return an item, contact AR Customer Service for an RMA number and shipping instructions. Returns from outside the United States are not permitted without prior authorization. If shipping from outside of the United States, closely follow all directions on the RMA form for return shipping and marking. See warranty statement at rear of manual.

4.2 DISASSEMBLY PROCEDURE



CAUTION:

Extreme caution should be exercised when troubleshooting this unit, particularly when measuring voltages in the power supply section of the unit. Hazardous voltages do exist in the unit that could cause serious injury to any personnel performing the measurements.

The enclosure and amplifier top cover can be removed to gain access to the low level and driver RF assemblies along with remote interfaces. The enclosure and amplifier side panels can be removed to gain access to final module and power supplies. The power combiner can be accessed through the front and rear access panels

4.3 COOLING SYSTEM

The liquid cooling system is a closed system which will operate for years without maintenance. The coolant level should extend into the coolant reservoir, with the heat exchanger full for optimum cooling. The coolant used is Dynalene HC-10. Dynalene HC is a non-toxic, non-flammable heat transfer fluid. It will provide protection to 14° F (-10° C) for operation and -20 ° F (-29° C) for storage. If coolant is removed from the system for any reason, the pump should not be activated; damage to the pump can occur if it is run without fluid.



**CAUTION:
EYE AND SKIN IRRITANT**

Contains potassium formate. Do not swallow. Do not allow eye contact or prolonged skin contact. For additional information, refer to Material Safety Data Sheet.

4.4 TROUBLESHOOTING



CAUTION:

The transistors used in the Model 5000A225B amplifier are LDMOS transistors. These devices are very reliable when installed in a suitable circuit, but they can be easily damaged by improper troubleshooting or handling techniques.

Use caution when troubleshooting the LDMOS; do not short the gate to the ground or to the drain.



CAUTION:

Use care when unpacking new LDMOS. The LDMOS packaging should only be opened at Electrostatic Discharge (ESD)-approved workstations, by individuals who are familiar with the handling of LDMOS and other ESD-sensitive devices.

Troubleshooting the Model 5000A225B in a logical manner can speed the solution to a problem. The settings of potentiometers (pots), capacitors (caps), or other variables should not be disturbed until other problems have been eliminated. Comparing the measured DC voltages to those shown on the schematics can solve many problems. Before measuring circuit voltages, first verify that the voltages to the circuits are correct.

Model 5000A225B troubleshooting symptoms and remedies are described in the sections that follow

- 4.4.1—General: Reading Faults
- 4.4.2—The Unit Cannot be Operated Remotely
- 4.4.3—Thermal Fault
- 4.4.4—Interlock Fault
- 4.4.5—Power Supply Faults
- 4.4.6—Amplifier Faults
- 4.4.7—ALC Fault
- 4.4.8—Low or No Power Output (DC Tests)
- 4.4.9—Low or No Power Output (RF Test)

4.4.1 General - Reading Faults

The Model 5000A225B incorporates relatively simple fault detection circuitry, which makes use of the digital display panel to alert the user or technician which component(s) need service. Use of these indications can usually expedite troubleshooting of the amplifier. Most faults can be immediately determined down to the assembly level. If a reset is still indicated, turn off the RF power signal to the input of the amplifier, read and record the fault indication displayed on the digital control panel for later reference. Then, use the RESET function to see if the fault clears. If the fault clears, slowly bring the amplifier's drive level back up and ensure that recommended RF power levels are not exceeded. If the fault indication is no longer visible, the fault may have been brought about by a temporary transient condition, component thermal condition or excessive RF drive to the amplifier's input. If the fault does not clear with the RF drive off, some other problem exists in the amplifier.

The digital control panel of the 5000A225B indicates the output power from the 5000A225B and the power reflected back to it. If the reflected power is very high, with respect to the forward power, this could indicate that the output coax cable is defective or that the load being driven has a high VSWR.

4.4.2 The Unit Cannot Be Operated Remotely

1. Verify that the front panel key-switch is set to the REMOTE position.
2. Verify that the unit operates locally by setting the key-switch to the LOCAL position; if the unit does not operate locally, see 4.4.1 of this manual.
3. Check the position of the ADDRESS via the control software on the front panel touch screen as shown in Figure 2-3 herein. (See Section 2 of this manual for the proper ADDRESS settings.)

4.4.3 Thermal Fault (Schematic 10049587)

During a Thermal Fault, the front panel display should read THERMAL AX.

1. Try to reset the unit; if the unit resets and operates normally, check to see that the cooling fans are operating normally and that the air inlet on the sides of the unit and the air outlets on the rear of the unit are not blocked or impeded.
2. If the unit does not reset and the cooling fans are operating normally, check the voltage at the A5A3 Switch Breakout Assembly, J5, Pins 16-23, and the A11 Switch Breakout Assembly, J5, Pins 16-23. It should be $\leq 0.1V$.
3. If the voltage on A5A3 J5 or A11, Pins 16-23 is high, check the connection to J3-1 and C6 on the suspect module assembly.

4.4.3.1 Flow Fault (Schematics 10049587, 10049584)

During a flow fault the front panel should read CDU FLOW

1. Verify the fluid reservoir is filled to $\frac{3}{4}$ of its volume with proper fluid (Dynalene HC-10). If amplifier is used in a temperature-controlled environment where freezing temperature is not possible, then distilled water can be used to top off the reservoir. It is not recommended to use more than 30% distilled water to Dynalene HC-10 or corrosive inhibitors will be affected. **Never use de-ionized water.**
2. Measure both pumps P1 pins 1 & 2 for +24 VDC. Verify pumps are operational.
3. Measure both flow sensors P1 pin 2 for +24 VDC. Measure P1 pin 3 voltage. It should be >3.5 VDC when operating properly.

4.4.3.2 Level Fault (Schematic 10049587, 10049584)

During a coolant level fault, the front panel should read CDU LEVEL.

1. Verify the fluid reservoir is filled to $\frac{3}{4}$ of its volume with proper fluid (Dynalene HC-10). If amplifier is used in a temperature-controlled environment where freezing temperature is not possible, then distilled water can be used to top off the reservoir. It is not recommended to use more than 30% distilled water to Dynalene HC-10 or corrosive inhibitors will be affected. **Never use de-ionized water.**
2. Measure level sensor P1 pin 2 for +24 VDC. Measure P1 pin 3 voltage. It should be <1.0 VDC when operating properly.

4.4.4 Interlock Fault

The Model 5000A225B is equipped with an interlock connector, which is located on the rear panel. The interlock circuit can be used to sense the openings of doors to screen rooms, test chambers, and so forth, and to turn off RF energy when these doors are opened.

NOTE: The Model 5000A225B is shipped with a mating connector, which has a jumper between Pins 1 and 8 and 10 and 14, installed in the rear panel interlock connector. The unit will not operate unless the interlock circuit is closed.

4.4.4.1 Interlock Fault

1. In the event of an Interlock Fault, the front panel display should read INTERLOCK.
2. Check to see if it is safe to be power up the unit—are there personnel present in the screen room, or are doors to the screen room open?
3. After checking for safety, try to clear the Interlock Fault from the front panel by using the RESET switch.
4. If the Interlock Fault will not clear, check for continuity in the External Interlock Circuit (Pin 1 to Pin 8 in the connector, which mate with J7 in the rear panel).
5. Check the voltage on A5A3 J5, pin 13; it should be < 0.1V.
6. If the voltage on A5A3 J5, pin 13 is high, check the interlock line to ground.

4.4.4.2 AC Interlock Fault

1. In the event of an AC Interlock Fault, the front panel display should read AC INTERLOCK.
2. Check to see if it is safe to be power up the unit—are there personnel present in the screen room, or are doors to the screen room open?
3. After checking for safety, try to clear the Interlock Fault from the front panel by using the RESET switch.
4. If the AC Interlock Fault will not clear, check for continuity in the External Interlock Circuit (Pin 10 to Pin 14 in the connector, which mate with J7 in the rear panel).
5. Check the voltage on A5A3 J5, pin 14; it should be $< 0.1V$.
6. If the voltage on A5A3 J5, pin 14 is high, check the interlock line to ground.

4.4.5 Power Supply Faults (Schematic 10049587, 10048584)

4.4.5.1 PDU PS1 Fault (POWER FAIL)

The PDU PS1 power supply has POWER FAIL output which is normally low ($\leq 0.1V$) to the A5A3 J9, pin 4. If the PDU PS1 output fails, this output will go high ($\geq 4.0V$) and inhibit the A1 Pre-Amplifier Module.

4.4.5.2 PS1 and PS2 Rack (A, B, C, D) Fault (POWER FAIL)

The PS1 and PS2 rack power supplies have POWER FAIL output which is normally low ($\leq 0.1V$) to the A5A3 and A11, J5, pins 9 through 12. If the PS1 rack output fails, this output will go high ($\geq 4.0V$) and inhibit the A1 Pre-Amplifier Module.

4.4.6 Amplifier Faults (Diagrams 10049038, 10045130)

1. The fault output of the Driver module, A2, final modules A1 through A16 is sensed on A5A3, J5, pins 15 through 23, and the A11 J5, pins 16 through 23. A fault will measure $\leq 0.1V$. Under normal operation, these lines will measure $4.9V \pm 0.2V$.
2. Verify the correct voltages to the modules. Troubleshoot any incorrect voltages.

A1 Driver Module	A1 thru A8 Final Modules	A9 thru A16 Final Modules
FL1 = $+4.2V \pm 0.3V$	FL1 = $+50 \pm 0.3V$	FL1 = $+50 \pm 0.3V$
FL2 = $+28V \pm 0.3V$	FL5 = $-15 \pm 0.3V$	FL5 = $-15 \pm 0.3V$
FL3 = $+40V \pm 0.3V$	FL4 = $+15 \pm 0.3V$	FL4 = $+15 \pm 0.3V$
FL4 = $-15 \pm 0.3V$		

4.4.7 ALC Fault

Indication – ALC

As stated previously, the power limit controls could not limit either the forward or reverse power to the preset threshold. This can be a transient type of problem, if the fault can be cleared. If the fault cannot be cleared with no RF input drive power, then there is a malfunction in the ALC board or associated circuit.

4.4.8 Low or No Power Output (DC Tests) (Schematics 10048570, 10049170)

All indicators on the Model 5000A225B are normal, the front panel display reads **RF On**, and the cooling fans are operating.

1. Check the position of the RF Gain control—is it set to maximum gain?
2. Check the RF input to the unit—is it the correct amplitude and frequency?
3. Check the RF output connection from the unit—is it correctly connected to the load? Is the coaxial cable okay?
4. Check the following voltages on the Power Supply. If any of the voltages are out of tolerance, correct them before further troubleshooting.

Driver Assembly	PDU	PS1 Rack (A, B, C, D)
PS1 J18, pins 1 and 2	+5.0 V \pm 0.5 V	PS1 +24.0 V \pm 0.5 V
PS1 J18, pin 5	+15.0 V \pm 0.5 V	PS1 Rack +50.0 V \pm 0.5 V
PS1 J18, pin 8	-15.0 V \pm 0.5 V	PS2 Rack (A, B, C, D)
PS2	+40.0 V \pm 0.5 V	PS2 Rack +50.0 V \pm 0.5 V

5. Check the voltage on the feed thru caps of the A1 Pre-Amp/Driver, with the RF gain control at maximum gain. Troubleshoot any incorrect voltages.

FL2	+24 V	\pm 0.3 V
FL3	-15 V	\pm 0.3 V
FL1	+4.2 V	\pm 0.3 V

6. Check the voltages on the feed-thru caps of Driver Module A2.

FL1	+34.0 V	\pm 0.3 V
FL4	+15.0 V	\pm 0.3 V
FL5	-15.0 V	\pm 0.3 V

7. Check the voltages on the feed-thru caps of Final Modules A1 through A16.

FL1	+50.0 V	\pm 0.3 V
FL5	-15.0 V	\pm 0.3 V
FL4	+15.0 V	\pm 0.3 V

4.4.9 Low or No Power Output (RF Test)

NOTE: The DC Tests specified in Section 4.4.8 should be completed before conducting the RF tests specified in the following sections.

1. The Model 5000A225B's typical gain response at 0 dBm input and -20 dBm input is shown in Figures 4-1 and 4-2. The actual gain may vary considerably from that shown in Figure 4-1 but should be ≥ 67 dB (0.01-100MHz) and ≥ 65.5 dB (100MHz-225MHz). Figure 4-2 should be ≥ 70 dB (0.01-100MHz) and ≥ 68.5 dB (100MHz-225MHz).

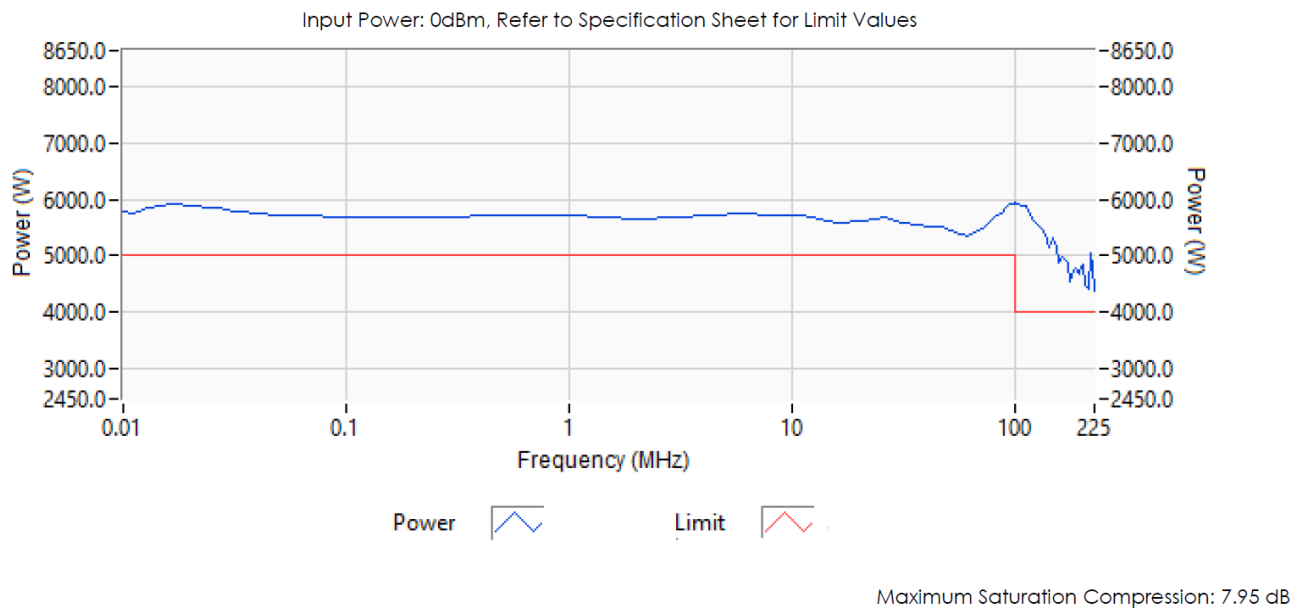

Figure 4-1. Typical Response at 0 dBm Input

Specification +/- 2.50dB

Measured +/- 1.65dB

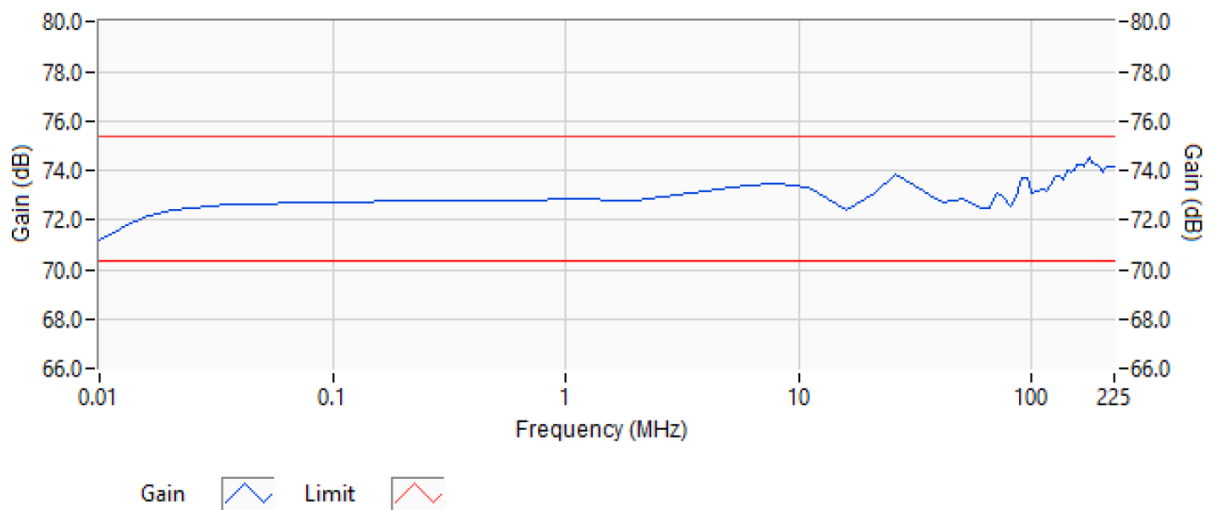

Figure 4-2. Typical Response at -20 dBm Input

4.5 LOCATING AND REPLACING MODULES

Remove rack enclosure top and right side panels to gain access to Final modules. See Figure 4-3.

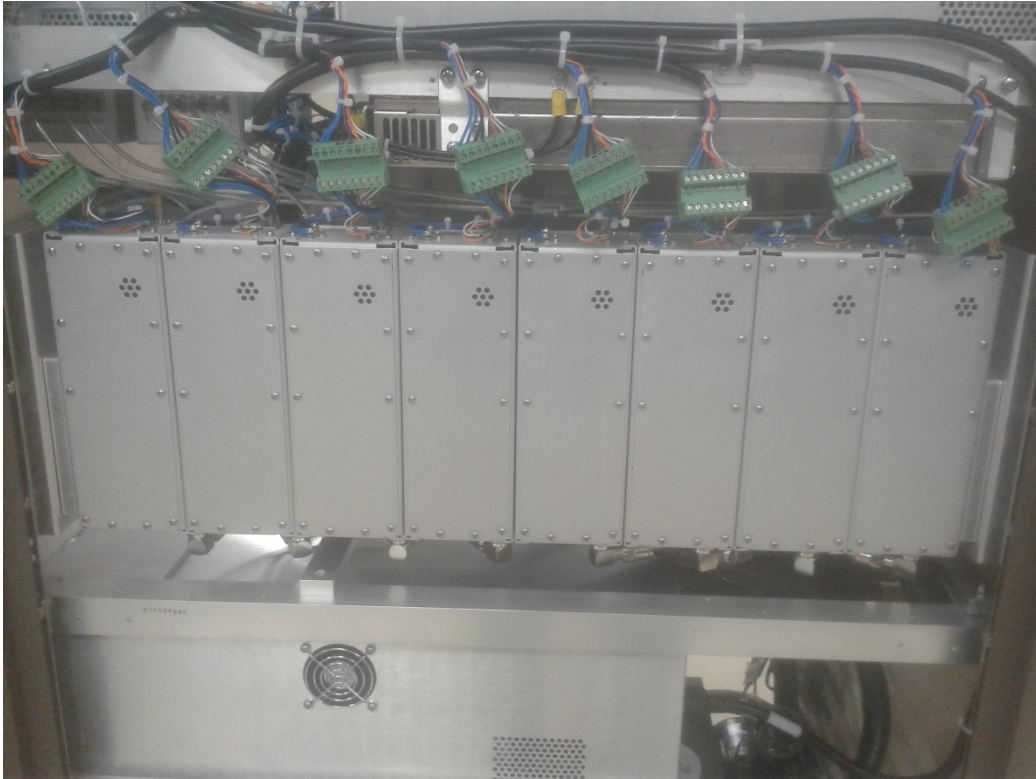

Figure 4-3. 5000A225B, Left Side, Modules A1-A8.

Disconnect the green connectors, the SMA input and output connectors and remove module top cover to access the eight socket head screws holding the module in place. See Figures 4-4 through 4-7.

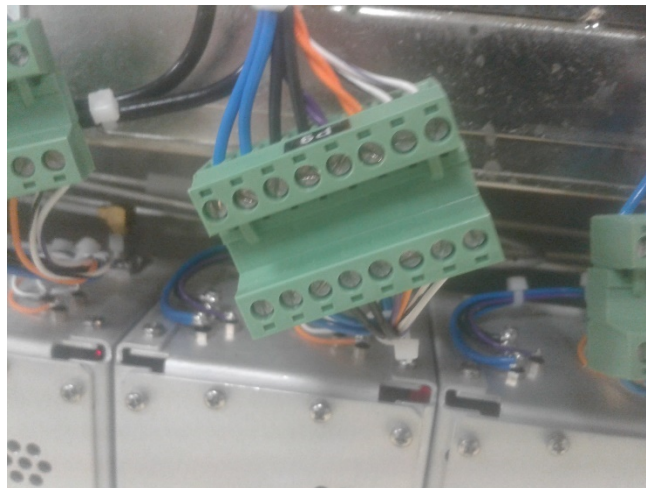

Figure 4-4. Connectors

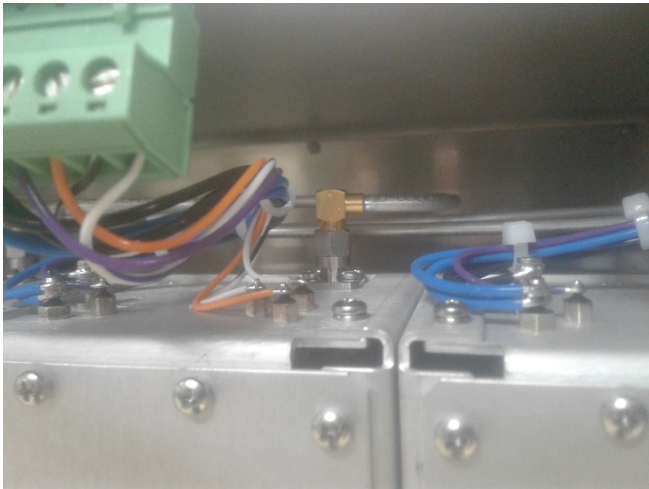

Figure 4-5. SMA Module Input

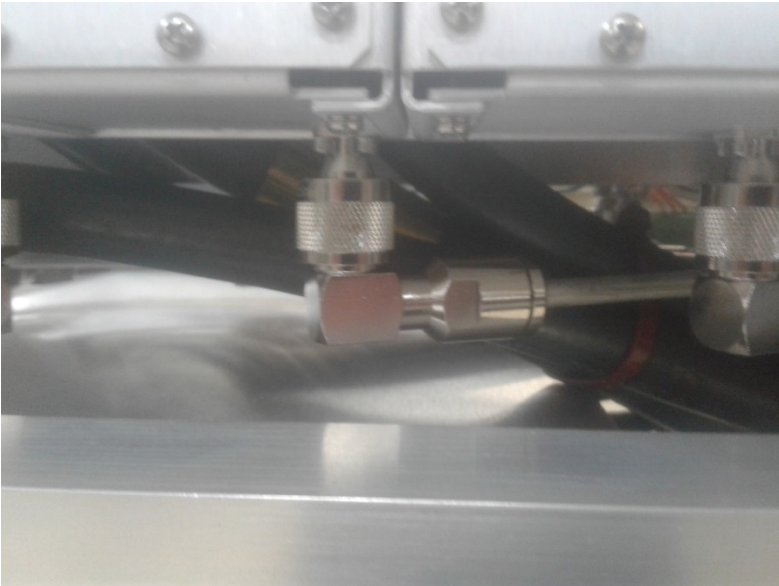

Figure 4-6. Final Module RF Output

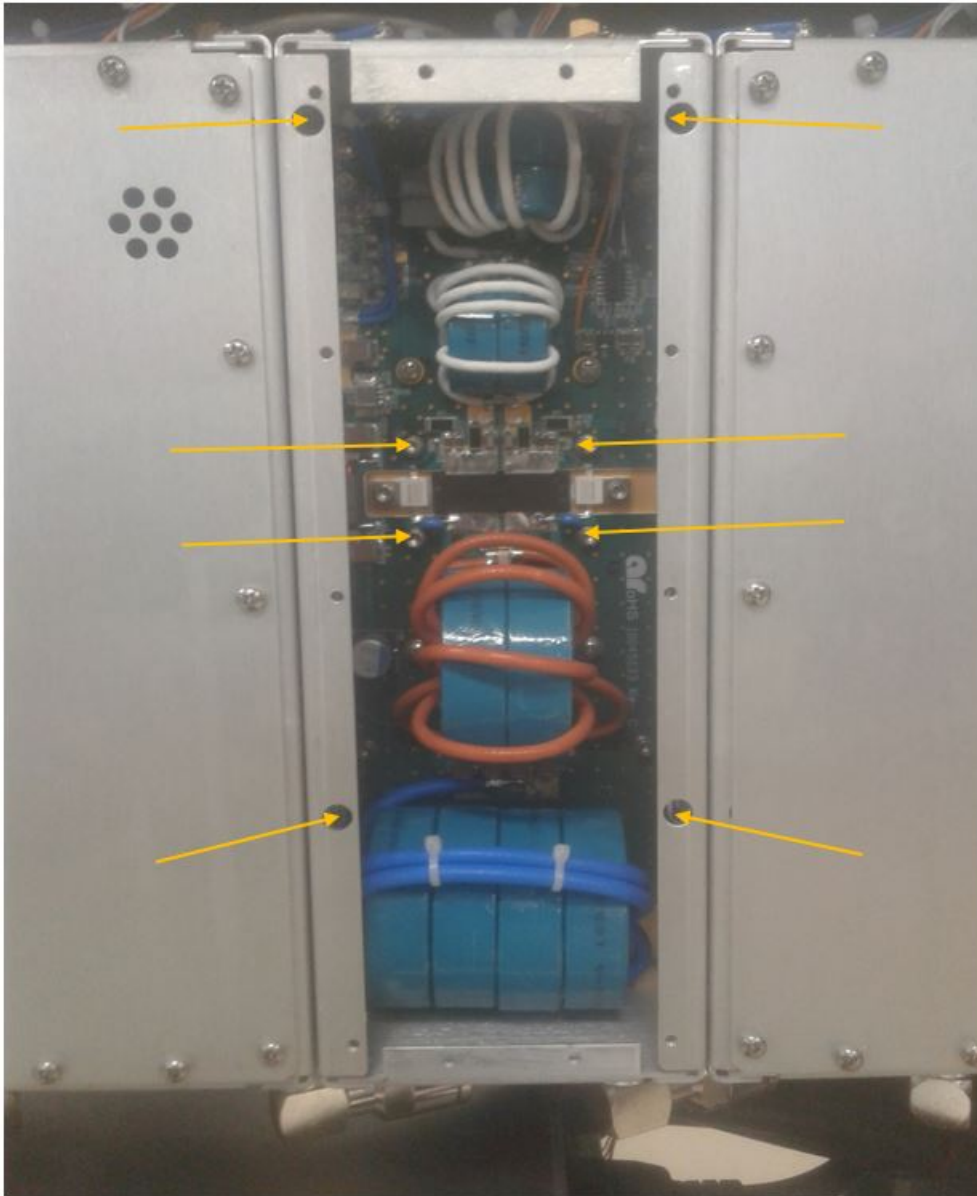

Figure 4-7. RF Module

Contact factory for Work Instruction 10049970 prior to installing module.

Install replacement module and secure with eight socket head screws. **Be sure to use the proper thermal grease on heat spreader.** Reconnect input and output cable and reconnect connector. Ensure amplifier functionality before reinstall side and enclosure covers.

Appendix A. Installing Software Upgrades

The 5000A225B has the capability to upgrade software. The first step that should be taken is to power-down the unit from the front panel.

1. Go to the AR Website and download the AR Firmware Upgrade Utility along with the model specific upgrade file for the device being upgraded.
2. Unzip the AR Firmware Upgrade Utility and run the installer executable.
3. After the installation completes, unzip the model specific firmware and save it to a safe place on the hard drive (do not rename the file). The utility will ask for this file later.
4. Run the AR Firmware Upgrade Utility and follow the instructions provided.
5. Once the utility successfully connects, click the Update button for the control firmware. The utility will prompt for the model specific firmware file.

WARRANTIES: LIMITATION OF LIABILITY

Seller warrants (i) that seller has title to the goods sold and (ii) that Amplifiers (all parts excluding traveling wave and vacuum tubes), Antennas, field monitors, field probes, field analyzers, field analyzer processor units, system controllers, system interlock, power meters, leak detectors, RF conducted probes, RF conducted clamps, Multi-tone, EMI receiver systems, RF down converters, RF conducted immunity systems, conducted immunity accessories, radiated immunity test systems, safety meters, safety sensor heads, tripods, directional couplers, waveguide adapters, termination loads, load attenuators, impedance stabilization networks, and coaxial cables will be free from defects in material and workmanship for a period of three (3) years from date of shipment shown on AR RF/Microwave Instrumentation invoice.

All modules, used in the amplifiers for the 1-6 GHz, 4-18 GHz, 6-18 GHz, all HPM products, and other applications, are hermetically-sealed. This sealing process protects the internal hybrid circuitry from humidity that could compromise the long term reliability of the product. These modules are not field-repairable and should *never* be opened outside of AR's Microelectronics Lab. The modules in these product lines have a security label on two sides of the modules between the housing and lid/cover. If the security label is removed and or cut, the warranty of the module will be voided.

Vacuum tubes in the 'L' series amplifiers, traveling-wave tubes in TWT amplifiers, and power heads will be free from defects in material and workmanship for a period of one (1) year.

Contact AR RF/Microwave Instrumentation for warranty information regarding items not listed.

Seller's sole responsibility in fulfilling these warranties shall be to repair or replace any goods which do not conform to the foregoing warranties or, at seller's option, to give buyer credit for defective goods. The warranty is valid only when used in the country specified at time of order. Warranty service must be obtained from the repair facility designated at that time. If warranty service is not available in the country where the equipment is to be used, it must be returned to AR RF/Microwave Instrumentation. Warranty service will be provided only for defective goods which are returned within the warranty period, freight costs prepaid to AR RF/Microwave Instrumentation or its designated repair facility.

There are no other warranties, express or implied, including any warranty of merchantability or fitness. Seller shall not be responsible for any incidental or consequential damages arising from any breach of warranty.

No person other than an officer of Amplifier Research Corporation, has any authority to bind seller to any affirmation, representation or warranty except as specifically included in the preceding terms and conditions.

