



# Operating and Service Manual

250T6G18

---

Model

10037990

---

Part Number

---

Serial Number





rf/microwave instrumentation

# *EC Declaration of Conformity*

We: Amplifier Research  
160 School House Road  
Souderton, PA. 18964

declare that our product(s);

the Model 250T6G18 series RF amplifiers

to which this declaration relates is in compliance with the following European directives:

Low Voltage Directive: 2014/35/EU

EMC Directive: 2014/30/EU

Supplementary Information:

Safety : EN 60215-1:1989

EN 61010-1:2010

EMC: EN 61000-6-2:2005, EN61000-6-4:2007

Year Mark Applied: 2016

I, the undersigned, hereby declare that the equipment specified above conforms to the above Directives and Standards.

Authorized officer of the company:

Patricia Thrasher  
Manager Quality & Service



# Instructions for European EMC Conformity



It is the responsibility of the user of this equipment to provide electromagnetic shielding, filtering and isolation which is necessary for EMC compliance to Directive 2014/30/EU. The equipment must therefore be operated in a shielded area which provides a sufficient level of attenuation to meet the radiated emissions and immunity specifications. The following minimum levels are suggested for use in accordance with the rated power of the equipment.

Rated Power	Minimum shielding attenuation
100 watts	50 dB
101 - 1000 watts	60 dB
1001 - 10,000 watts	70 dB

Since this equipment is designed to generate high levels of Radio Frequency energy, it is also essential that the user read and follow the “Instructions for Safe Operation” in this manual. If other equipment is operated in the shielded room it may be disturbed by the amplifier.



Der Benutzer dieses Gerätes ist dafür verantwortlich, daß die elektromagnetische Abschirmung und Filterung gewährleistet ist, welche gemäß Richtlinie 2014/30/EU notwendig ist. Das Gerät muß deshalb in einem geschirmten Raum betrieben werden, welcher eine ausreichenden Schirmung bietet, um die Emissions- und Störfestigkeitsspezifikation einzuhalten. Es werden folgenden Minimalwerte der Schirmdämpfung und Filterung in den unterschiedlichen Leistungsklassen empfohlen.

Hochfrequenzleistung	min. Schirmdämpfung
100 Watt	50 dB
101-1000 Watt	60 dB
1001-10.000 Watt	70 dB

Falls andere elektrische oder elektronische Geräte gleichzeitig mit dem Gerät betrieben werden, kann es zu Beeinflussungen kommen. Da das Gerät zur Erzeugung von Hochfrequenzenergie dient ist es daher auch unbedingt notwendig, daß der Benutzer die Sicherheitsvorschriften in der Bedienungsanleitung liest und einhält.



Il est de la responsabilité de l'utilisateur de cet équipement d'assurer la protection électromagnétique, le filtrage et l'isolation nécessaires, afin de se conformer à la directive 2014/30/EU concernant la C.E.M. Par conséquent, cet équipement doit être mis en fonctionnement dans une enceinte d'atténuation suffisante pour satisfaire aux spécifications d'émissivité et de susceptibilité. Pour une utilisation conforme, les niveaux d'atténuation minimums suivants sont suggérés en fonction de la puissance de sortie de l'équipement:

Puissance de sortie	Atténuation minimum de l'enceinte
100 Watts	50 dB
101 à 1.000 Watts	60 dB
1.001 à 10.000 Watts	70 dB

Puisque cet équipement est destiné à générer de forts niveaux R.F., il est essentiel que l'utilisateur se conforme aux instructions de sécurité indiquées dans ce manuel. Tout autre équipement en fonctionnement dans la cage de Faraday peut-être perturbé par l'amplificateur.



# INSTRUCTIONS FOR SAFE OPERATION









Observe the following safety guidelines to help ensure your own personal safety and to help protect your equipment and working environment from potential damage.

## INTENDED USE

This equipment is intended for general laboratory use in generating, controlling, and measuring levels of electromagnetic Radio Frequency (RF) energy. Ensure that the device is operated in a location which will control the radiated energy and will not cause injury or violate regulatory levels of electromagnetic interference.

## SAFETY SYMBOLS

These symbols may appear in your user manual or on equipment.

	This symbol is marked on the equipment when it is necessary for the user to refer to the manual for important safety information. The caution symbol denotes a potential hazard. Attention must be given to the statement to prevent damage, destruction, or harm.
	Dangerous voltages are present. Use extreme care.
	Indicates a terminal intended for connection to an external conductor for protection against electrical shock in case of a fault, or the terminal of a protective earth (ground) electrode.
	Indicates invisible laser radiation—do not view directly with optical instruments.
	Indicates frame or chassis ground connection terminal.
	Indicates alternating current.
	Indicates this product must not be disposed of with your other household waste.
	Indicates that the marked surface and adjacent surfaces can attain temperatures that may be hot to the touch.

## EQUIPMENT SETUP PRECAUTIONS



Review the user manual and become familiar with all safety markings and instructions. Protection provided by the equipment may be impaired if used in a manner not specified by AR RF/Microwave Instrumentation (AR).

- Follow all lifting instructions specified in this document.
- Place the equipment on a hard, level surface.
- Do not use the equipment in a wet environment, for example, near a sink, or in a wet basement.
- Position your equipment so that the power switch is easily accessible.
- Leave 10.2 cm (4 in) minimum of clearance on all vented sides of the equipment to permit the airflow required for proper ventilation. Do not restrict airflow into the equipment by blocking

any vents or air intakes. Restricting airflow can result in damage to the equipment, intermittent shut-downs or safety hazards.

- Keep equipment away from extremely hot or cold temperatures to ensure that it is used within the specified operating range.
- While installing accessories such as antennas, directional couplers and field probes, take care to avoid any exposure to hazardous RF levels.
- Ensure that nothing rests on your equipment's cables and that the cables are not located where they can be stepped on or tripped over.
- Move equipment with care; ensure that all casters and/or cables are firmly connected to the system. Avoid sudden stops and uneven surfaces.

## BEFORE APPLYING POWER

Your AR equipment may have more than one power supply cable. Use only approved power cable(s). If you have not been provided with a power cable for the equipment or for any AC-powered option intended for the equipment, purchase a power cable that is approved for use in your country. The power cable must be rated for the equipment and for the voltage and current marked on the equipment's electrical ratings label.



Incorrectly installing or using an incompatible line voltage may increase the risk of fire or other hazards. To help prevent electric shock, plug the equipment and peripheral power cables into properly grounded electrical outlets. These cables are equipped with three-prong plugs to help ensure proper grounding. Do not use adapter plugs or remove the grounding prong from a cable.

Do not modify power cables or plugs. Consult a licensed electrician or AR trained service technician for equipment modifications. Always follow your local/national wiring rules.



***Do not operate the equipment if there is physical damage, missing hardware, or missing panels.***

## SAFETY GROUND



This equipment is provided with a protective earth terminal. The mains power source to the equipment must supply an uninterrupted safety ground of sufficient size to attach wiring terminals, power cord, or supplied power cord set. ***DO NOT USE this equipment if this protection is impaired.***

# INSTRUCTIONS FOR SAFE OPERATION

## HAZARDOUS RF VOLTAGES



The RF voltages on the center pin of an RF output connector can be hazardous. The RF output connector should be connected to a load before AC power is applied to the equipment. Do not come into contact with the center pin of the RF output connector or accessories connected to it. Place the equipment in a non-operating condition before disconnecting or connecting the load to the RF output connector.

## ACOUSTIC LIMITATIONS

If equipment noise exceeds 80dB, ear protection is required.

## MAINTENANCE CAUTION

Adjustment, maintenance, or repair of the equipment must be performed only by qualified personnel. Hazardous energy may be present while protective covers are removed from the equipment even if disconnected from the power source. Contact may result in personal injury. Replacement fuses are required to be of specific type and current rating.

## ENVIRONMENTAL CONDITIONS

Unless otherwise stated on the product specification sheet, this equipment is designed to be safe under the following environmental conditions:

- Indoor use
- Altitude up to 2000m
- Temperature of 5°C to 40°C
- Maximum relative humidity 80% for temperatures up to 31°C. Decreasing linearly to 50% at 40°C.
- Main supply voltage fluctuations not to exceed  $\pm 10\%$  of the nominal voltage or minimum and maximum autoranging values.
- Pollution degree 2: Normally non-conductive with occasional condensation. While the equipment will not cause hazardous condition over this environmental range, its performance may vary.

## EQUIPMENT CONTAINING LASERS



AR Field Probes (FL/PL Series) and Field Analyzers (FA Series) are Class 1 laser products containing embedded Class 4 lasers. Under normal use, the laser radiation is completely contained within the fiber optic cables and poses no threat of exposure. Safety interlocks ensure that the laser is not activated unless the cables are properly connected. Always exercise caution when using or maintaining laser products. Do not view directly with optical instruments.

## RF ANTENNAS

- This equipment (antenna or antenna assembly) may be heavy, requiring two persons to lift. Use caution when installing or removing unit. Follow all equipment setup and lifting instructions specified in this document.
- Ensure connectors are appropriate for intended operation. Connectors are specified in the user manual and product specification sheet.
- Do not exceed the maximum RF input level stated in the specifications. Refer to the user manual and product specification sheet to determine the applicable RF levels.
- Excessive RF input could damage the equipment or connectors, causing safety hazards.
- When in operation, the RF voltages on the antenna elements can be hazardous. Do not come into contact with the antenna or elements when the RF input connector is connected to a live RF source.
- To avoid injury to personnel and accidental damage to power amplifier or antenna, disable the RF output of power amplifier before connecting or disconnecting the input connection to the antenna.
- Perform periodic inspections of antenna and field probe systems to verify calibration due date, proper operation, and overall condition of equipment.

## RACK MOUNTED TWT MODELS

Some TWT models are supplied without the removable enclosure offered for benchtop use. These rack-mountable models may be supplied with either carry handles or slides and front handles installed. Follow all lifting instructions specified in this document and installation instructions supplied in the TWT user manual.

## LIFTING INSTRUCTIONS FOR AR EQUIPMENT

Because most products must be handled during distribution, assembly and use, the risk of serious injury due to unsafe product handling should be a fundamental consideration of every user. An authoritative guideline for eliminating unwarranted risk of injury caused by lifting is provided by the NIOSH Work Practices (Publication #94-110) available at:



<https://www.cdc.gov/niosh/docs/94-110/pdfs/94-110.pdf>.

In general, observe the following guidelines for lifting a weight of 50 lb or more:

- Use lifting eye (for floor standing) or side handles (table top) to lift unit only.
- Use equipment of adequate capacity to lift and support unit.
- If using forklift to move unit, be sure forks are long enough to extend beyond the side of the unit.
- For additional information, follow the link specified above.



# HINWEISE FÜR DEN SICHEREN GEBRAUCH









Bitte beachten Sie die folgenden Hinweise zum Schutz Ihrer persönlichen Sicherheit und um Ihre Ausrüstung und Ihren Arbeitsplatz vor möglichen Schäden zu bewahren.

## VORGESEHENE VERWENDUNG

Dieses Gerät ist für den allgemeinen Einsatz im Labor bestimmt. Es dient der Erzeugung, Steuerung und Messung von elektromagnetischer Hochfrequenzenergie (RF). Stellen Sie sicher, dass das Gerät an einem Ort in Betrieb genommen wird, an dem die abgestrahlte Energie gesteuert werden kann, so dass niemand Schaden erfährt und elektromagnetische Störungen vermieden werden.

## SICHERHEITSSYMBOL

Einige dieser Symbole befinden sich sowohl in der Bedienungsanleitung als auch auf dem Gerät selbst.

	Dieses Symbol befindet sich auf dem Gerät und weist darauf hin, dass der Nutzer an dieser Stelle wichtige Sicherheitsinformationen in der Bedienungsanleitung studieren soll. Das Warnsymbol weist auf eine mögliche Gefahr hin. Zur Vermeidung von Personen- oder Sachschäden gilt es, die Hinweise zu beachten.
	Gefährliche elektrische Spannungen sind vorhanden. Höchste Vorsicht ist geboten.
	Weist darauf hin, dass an dieser Stelle eine Klemme für den Anschluss an einen Außenleiter anzubringen ist, zum Schutz vor einem Stromschlag oder im Fall einer auftretenden Störung, oder dass eine Klemme anzubringen ist, die als schützende Erdungselektrode fungiert.
	Zeigt unsichtbare Laserstrahlung an – nicht direkt hineinschauen.
	Weist auf eine Rahmen- oder Chassis-Anschlussklemme hin.
	Zeigt Wechselstrom an.
	Weist darauf hin, dass dieses Produkt nicht mit Ihrem restlichen Hausmüll entsorgt werden darf.
	Weist darauf hin, dass die markierte Oberfläche und benachbarte Flächen extrem heiße Temperaturen erreichen können und daher nicht angefasst werden sollten.

## SICHERHEITSHINWEISE FÜR DEN AUFBAU DES GERÄTS



Lesen Sie die Bedienungsanleitung aufmerksam durch und machen Sie sich mit allen Sicherheitsmarkierungen und Anweisungen vertraut. Die Sicherheit kann beeinträchtigt sein, falls das Gerät in einer anderen Weise verwendet wird, als von der AR RF/Microwave Instrumentation (AR) vorgegeben ist.

- Zum Heben und Transport folgen Sie allen in dieser Anleitung angegebenen Anweisungen.
- Platzieren Sie das Gerät auf einer harten, ebenen Oberfläche.
- Verwenden Sie das Gerät nicht in feuchter Umgebung, zum Beispiel in der Nähe einer Spüle oder in einem feuchten Keller.
- Platzieren Sie Ihr Gerät so, dass der Netzschalter leicht zugänglich ist.

- Halten Sie einen Mindestabstand von 10,2 cm (4 in) auf allen belüfteten Seiten des Geräts ein, um eine ausreichende Luftzirkulation zu gewährleisten. Beeinträchtigen Sie den Luftstrom des Geräts nicht, indem Sie Lüftungsöffnungen oder den Lufteinlass blockieren. Wird der Luftstrom eingeschränkt, kann dies zu Schäden am Gerät, periodischen Abschaltungen und anderen Gefahren führen.
- Halten Sie das Gerät von extrem heißen oder kalten Temperaturen fern, um sicherzustellen, dass es nur in dem vorgeschriebenen Bedienungsbereich verwendet wird.
- Achten Sie beim Installieren von Zubehör wie Antennen, Richtungskupplungen und Feldsonden darauf, dass sie keinen gefährlichen HF-Werten ausgesetzt sind.
- Stellen Sie sicher, dass nichts auf den Kabeln Ihres Geräts steht. Bringen Sie die Kabel so an, dass niemand darauf treten oder darüber stolpern kann.
- Seien Sie vorsichtig, wenn Sie das Gerät bewegen. Achten Sie darauf, dass alle Rollen und/oder Kabel fest mit dem System verbunden sind. Vermeiden Sie plötzliche Stopps und Oberflächen, die nicht eben sind.

## BEVOR SIE DAS GERÄT ANSCHLIESSEN

Ihre AR-Ausrüstung hat möglicherweise mehr als ein Stromversorgungskabel. Verwenden Sie nur zugelassene Stromkabel. Falls Sie kein Stromkabel oder AC-Netzkabel für dieses Gerät haben, kaufen Sie ein Stromkabel, das für den Einsatz in Ihrem Land zugelassen ist. Das Stromkabel muss für das Gerät, die Spannung und den Strom, die auf dem elektrischen Kennzeichnungsetikett des Geräts markiert sind, zugelassen sein.



Bei einer fehlerhaften Installation oder falls eine Netzspannung verwendet wird, die nicht mit dem Gerät kompatibel ist, erhöht sich die Brandgefahr. Auch andere Gefahren können auftreten. Um einen Stromschlag zu verhindern, schließen Sie das Gerät und die peripheren Stromkabel an ordnungsgemäß geerdete Steckdosen an. Die Kabel sind mit dreipoligen Steckern ausgestattet, um eine korrekte Erdung zu gewährleisten. Verwenden Sie keine Adapter. Entfernen Sie niemals die Erdungsstange eines Kabels.

Modifizieren Sie niemals die Stromkabel oder Stecker. Konsultieren Sie einen lizenzierten Elektriker oder AR-ausgebildeten Servicetechniker, falls Veränderungen am Gerät durchgeführt werden müssen. Halten Sie sich stets an die nationalen/örtlichen Verdrahtungsregeln.



**Schalten Sie das Gerät nicht ein, falls es äußerlich beschädigt ist oder Hardware-Teile oder Konsolen fehlen.**

## SYSTEMERDUNG



Dieses Gerät ist mit einer Schutzerdklemme ausgestattet. Die Netzstromquelle muss dem Gerät eine ununterbrochene Systemerdung von ausreichender Größe zur Verfügung stellen, damit Kabelklemmen, Netzkabel oder mitgeliefertes Netzkabel ordentlich befestigt werden können. **VERWENDEN SIE DIESES GERÄT NICHT, wenn dieser Schutz beeinträchtigt ist.**

# HINWEISE FÜR DEN SICHEREN GEBRAUCH

## GEFÄHRLICHE HF-SPANNUNGEN



Die HF-Spannungen am mittleren Pin eines HF-Ausgangsanschlusses können gefährlich sein. Der HF-Ausgangsanschluss sollte an eine Last angeschlossen werden, bevor das Gerät ans Stromnetz angeschlossen wird. Kommen Sie nicht mit dem Mittelstift des HF-Ausgangsanschlusses oder dem damit verbundenen Zubehör in Kontakt. Bevor Sie die Last vom HF-Ausgang trennen oder diese anschließen, stellen Sie das Gerät in einen nicht betriebsfähigen Zustand.

## HÖRSCHUTZ

Sollten die Geräusche, die das Gerät verursacht, 80dB überschreiten, ist Gehörschutz erforderlich.

## WARTUNGSHINWEISE

Einstellung, Wartung oder Reparaturen der Ausrüstung dürfen nur von qualifizierten Fachleuten durchgeführt werden. Gefährliche Spannungen können auftreten, wenn Schutzabdeckungen vom Gerät entfernt werden, auch wenn es nicht an die Stromquelle angeschlossen ist. Kontakt kann zu Verletzungen führen. Es können nur bestimmte Ersatzsicherungen mit speziellem Nennstrom verwendet werden.

## UMGEBUNGSBEDINGUNGEN

Sofern auf dem Produktspezifikations-Blatt nichts anderes angegeben ist, ist dieses Gerät unter folgenden Bedingungen sicher einsetzbar:

- Gebrauch in Innenräumen
- Höhe bis zu 2000m
- Temperaturen von 5°C bis 40°C
- Maximale relative Luftfeuchtigkeit 80% bei Temperaturen bis 31°C. Lineare Abnahme auf 50% bei 40°C.
- Netzspannungsschwankungen sollen nicht mehr als  $\pm 10\%$  der Nennspannung oder der minimal und maximal eingestellten Werte betragen.
- Verschmutzungsgrad 2: Normalerweise nichtleitfähige Verschmutzung mit gelegentlicher Kondensation. Das Gerät wird bei Einsatz in diesem Bereich keine Gefahr verursachen, die Leistung kann dennoch variieren.

## LASER-INFORMATION



AR - Feldsonden (FL/PL-Serie) und Feldanalysatoren (FA-Serie) sind Laserprodukte der Klasse 1 mit eingebetteten Klasse-4-Lasern. Bei normalem Gebrauch kann der Laserstrahlung nicht aus den Glasfaserkabel herausdringen. Sicherheitsverriegelungen sorgen dafür, dass der Laser nur aktiviert wird, wenn die Kabel richtig angeschlossen sind. Lassen Sie stets Vorsicht walten bei der Verwendung oder Wartung von Laserprodukten. Niemals direkt hineinschauen.

## HF-ANTENNEN

- Die Ausrüstung (Antenne oder Antennenmontage) ist mitunter schwer. Die Montage erfordert daher oft zwei Personen. Folgen Sie allen in diesem Dokument angegebenen Anweisungen zur Anbringung.
- Stellen Sie sicher, dass alle Anschlüsse für den beabsichtigten Betrieb geeignet sind. Informationen zu den Anschlüssen erhalten Sie im Benutzerhandbuch und im Produktspezifikationsblatt.
- Überschreiten Sie nicht den in Spezifikationen angegebenen maximalen HF-Eingangspegel. Informationen zum geeigneten HF-Pegel erhalten Sie im Benutzerhandbuch und im Produktspezifikationsblatt.
- Ein übermäßiger HF-Eingang könnte das Gerät oder die Anschlüsse beschädigen, was zu Sicherheitsrisiken führt.
- Im Betrieb können die HF-Spannungen an den Antennenelementen gefährlich sein. Kommen Sie nicht mit der Antenne oder Antennenelementen in Kontakt, wenn der HF-Eingang an eine live-HF-Quelle angeschlossen ist.
- Um Verletzungen an Personen, am Leistungsverstärker oder der Antenne zu vermeiden, deaktivieren Sie den HF-Ausgang des Leistungsverstärkers, bevor sie die Eingangsverbindung an die Antenne anschließen oder trennen.
- Kontrollieren Sie die Antennen und die Feldsonde regelmäßig, um die nächstfällige Kalibrierung, den ordnungsgemäßen Betrieb und den Gesamtzustand der Ausrüstung zu überprüfen.

## RACK MONTIERBARE TWT-MODELLE

Einige TWT-Modelle kommen ohne die abnehmbare Überdachung, die zur Verwendung als Tischgerät dient. Diese rack-montierbaren Modelle verfügen entweder über installierte Tragegriffe oder Rutschflächen. Befolgen Sie alle in diesem Dokument angegebenen Hebehinweise sowie die Installationsanweisungen in der TWT-Bedienungsanleitung.

## HEBEANWEISUNGEN FÜR AR-GERÄTE

Die meisten Geräte müssen während des Versands, der Montage und des Gebrauchs transportiert werden. Jeder Nutzer sollte sich über das Risiko von schweren Verletzungen durch unsachgemäße Produkthandhabung bewusst sein. Leitlinien zur Beseitigung von vermeidbaren Verletzungsrisikos, die beim Heben entstehen können, werden in den NIOSH-Arbeitspraktiken (Veröffentlichung # 94-110) zur Verfügung gestellt:



<https://www.cdc.gov/niosh/docs/94-110/pdfs/94-110.pdf>.

Beachten folgende, allgemeine Richtlinien zum Heben eines Gewichts von 50 Pfund oder mehr:

- Verwenden Sie zum Heben der Einheit eine Hebeöse (für Platzierung auf dem Boden) oder Seitengriffe (für Platzierung auf einer Arbeitsplatte).
- Verwenden Sie Geräte mit ausreichender Kapazität zum Heben und Stützen.
- Falls Sie einen Gabelstapler verwenden, achten Sie darauf, dass die Gabeln lange genug sind und über die Seiten der Einheit hinausreichen.
- Für weitere Informationen folgen Sie dem oben angegebenen Link.

# INSTRUCTIONS POUR UN FONCTIONNEMENT EN TOUTE SÉCURITÉ









Respectez les consignes de sécurité suivantes pour veiller à votre propre sécurité et vous aider à protéger votre équipement et votre milieu de travail de dommages potentiels.

## USAGE PRÉVU

Cet équipement est prévu pour un usage général en laboratoire afin de générer, contrôler et mesurer les niveaux d'énergie de radiofréquence (RF) électromagnétique. Assurez-vous que l'appareil est utilisé dans un endroit qui contrôlera l'énergie rayonnante et ne causera pas de blessure, ni ne violera les niveaux réglementaires d'interférence électromagnétique.

## SYMBOLES DE SÉCURITÉ

Ces symboles peuvent apparaître dans votre manuel d'utilisation ou sur l'équipement.

	Ce symbole est apposé sur l'équipement lorsque l'utilisateur doit se référer au manuel pour des informations importantes concernant la sécurité. Le symbole de mise en garde indique un danger potentiel. Vous devez accorder une attention à la déclaration pour éviter tout dommage, destruction ou blessure.
	Présence de tensions dangereuses, soyez très prudent.
	Indique une borne de connexion d'un conducteur externe pour une protection contre l'électrocution en cas de défaillance ou la borne d'une électrode de mise à la terre de protection.
	Indique un rayonnement laser invisible – ne regardez pas directement avec des instruments optiques.
	Indique la borne de connexion de la mise à la terre du cadre ou du châssis.
	Indique un courant alternatif.
	Indique que ce produit ne doit pas être jeté avec vos autres déchets ménagers.
	Indique que la surface marquée et les surfaces adjacentes peuvent atteindre des températures qui risquent d'être chaudes au toucher.

## PRÉCAUTIONS D'INSTALLATION DE L'ÉQUIPEMENT



Lisez le manuel d'utilisateur et familiarisez-vous avec tous les marquages et consignes de sécurité. La protection fournie par l'équipement peut être affaiblie s'il est utilisé d'une manière non indiquée par AR RF/instrumentation à hyperfréquence (AR).

- Respectez toutes les instructions de levage indiquées dans ce document.
- Placez l'équipement sur une surface dure et plane.

- N'utilisez pas l'équipement dans un environnement humide, par exemple près d'un lavabo, ou dans un sous-sol humide.
- Positionnez votre équipement de sorte que l'interrupteur d'alimentation soit facilement accessible.
- Laissez un espace minimal de 10,2 cm (4 in) de tous les côtés ventilés de l'équipement pour permettre le flux d'air nécessaire à une bonne ventilation. Ne limitez pas le flux d'air allant dans l'équipement en bloquant tout évent ou entrée d'air. La restriction du flux d'air peut endommager l'équipement, causer des coupures intermittentes ou des dangers pour la sécurité.
- Tenez l'équipement à l'écart de températures extrêmement chaudes ou froides pour veiller à ce qu'il soit utilisé dans la plage de fonctionnement indiquée.
- Lorsque vous installez des accessoires tels que des antennes, des coupleurs directionnels et des sondes de champ, prenez soin d'éviter toute exposition à des niveaux RF dangereux.
- Assurez-vous que rien n'est posé sur les câbles de votre équipement et que les câbles ne se trouvent pas à des endroits où l'on peut marcher dessus ou trébucher.
- Déplacez l'équipement avec soin ; veillez à ce que tous les câbles et/ou roulettes soient solidement raccordés au système. Évitez les arrêts brusques et les surfaces irrégulières.

## AVANT LA MISE SOUS TENSION

Votre équipement AR peut disposer de plus d'un câble d'alimentation électrique. Utilisez uniquement un ou des câbles d'alimentation approuvés. Si un câble d'alimentation ne vous a pas été fourni avec l'équipement ou pour toute option alimentée en courant alternatif prévue pour l'équipement, achetez un câble d'alimentation qui est approuvé pour être utilisé dans votre pays. Le câble d'alimentation doit être prévu pour l'équipement et pour le courant et la tension indiqués sur l'étiquette de classement électrique de l'équipement.



Installer ou utiliser de façon incorrecte une tension de ligne incompatible peut augmenter le risque d'incendie ou d'autres dangers. Pour aider à éviter toute électrocution, branchez l'équipement et les câbles d'alimentation périphériques dans des prises électriques correctement mises à la terre. Ces câbles sont équipés de prises à trois broches pour veiller à une bonne mise à la terre. N'utilisez pas d'adaptateur de prise, ni ne retirez la broche de mise à la terre d'un câble.

Ne modifiez pas les câbles ou les prises d'alimentation. Consultez un électricien agréé ou un technicien d'entretien AR qualifié pour les modifications d'équipement. Respectez toujours les règles locales/nationales de câblage.



*N'utilisez pas l'équipement s'il est physiquement endommagé ou s'il manque des pièces ou des panneaux.*

## MISE À LA TERRE DE SÉCURITÉ



Cet équipement est fourni avec une borne de mise à la terre de protection. La source d'alimentation secteur à l'équipement doit fournir une mise à la terre de sécurité ininterrompue de taille suffisante pour attacher les bornes de câblage, le cordon d'alimentation ou l'ensemble de câbles d'alimentation fourni. **N'UTILISEZ PAS cet équipement si cette protection est affaiblie.**

# INSTRUCTIONS POUR UN FONCTIONNEMENT EN TOUTE SÉCURITÉ

## TENSIONS RF DANGEREUSES

Les tensions RF sur la broche centrale d'un connecteur de sortie RF peuvent être dangereuses. Le connecteur de sortie RF doit être connecté à une charge avant que l'équipement ne reçoive l'alimentation en courant alternatif. N'entrez pas en contact avec la broche centrale du connecteur de sortie RF ou des accessoires raccordés à celle-ci. L'équipement doit être dans un état de non fonctionnement avant de déconnecter ou de connecter la charge au connecteur de sortie RF.



## LIMITES ACOUSTIQUES

Si le bruit de l'équipement dépasse 80dB, une protection auditive est nécessaire.

## AVERTISSEMENT CONCERNANT L'ENTRETIEN

Le réglage, l'entretien ou la réparation de l'équipement doivent être effectués uniquement par un personnel qualifié. Une énergie dangereuse peut être présente lorsque les couvercles de protection sont retirés de l'équipement, même si celui-ci est déconnecté de la source d'alimentation. Un contact peut causer des blessures. Les fusibles de remplacement doivent être d'un type et courant nominal spécifiques.

## CONDITIONS ENVIRONNEMENTALES

Sauf mention contraire sur la fiche signalétique du produit, cet équipement est conçu pour être sécuritaire dans les conditions environnementales suivantes :

- Utilisation à l'intérieur
- Altitude jusqu'à 2000 m
- Température de 5°C à 40°C
- Humidité relative maximale de 80 % pour les températures jusqu'à 31°C. Décroissance linéaire à 50 % à 40°C.
- Les fluctuations de tension d'alimentation principale ne doivent pas dépasser  $\pm 10$  % de la tension nominale ou des valeurs d'autorégulation minimales et maximales.
- Degré de pollution 2 : Normalement non conducteur avec une condensation occasionnelle. Bien que l'équipement ne cause pas de condition dangereuse dans cette gamme environnementale, sa performance peut varier.

## ÉQUIPEMENT CONTENANT DES LASERS



Les sondes de champ AR (série FL/PL) et les analyseurs de champ (série FA) sont des produits laser de classe 1 contenant des lasers intégrés de classe 4. Lors d'une utilisation normale, le rayonnement laser est entièrement contenu dans les câbles à fibres optiques et ne pose aucun risque d'exposition. Des verrouillages de sécurité veillent à ce que le laser ne soit pas activé à moins que les câbles ne soient correctement raccordés. Soyez toujours prudent lorsque vous utilisez ou entretenez des produits laser. Ne regardez pas directement avec des instruments optiques.

## ANTENNES RF

- Cet équipement (antenne ou ensemble antenne) peut être lourd nécessitant deux personnes pour le soulever. Soyez prudent lorsque vous installez ou retirez l'unité. Respectez toutes les instructions concernant l'installation et le levage de l'équipement indiquées dans ce document.

- Assurez-vous que les connecteurs sont appropriés pour l'utilisation prévue. Les connecteurs sont indiqués dans le manuel d'utilisation et la fiche signalétique du produit.
- Ne dépassez pas le niveau d'entrée RF maximal indiqué dans les spécifications. Référez-vous au manuel d'utilisation et à la fiche signalétique du produit pour déterminer les niveaux RF applicables.
- Une entrée RF excessive pourrait endommager l'équipement ou les connecteurs causant des dangers pour la sécurité.
- Lorsque l'équipement fonctionne, les tensions RF sur les éléments de l'antenne peuvent être dangereuses. N'entrez pas en contact avec l'antenne ou les éléments lorsque le connecteur d'entrée RF est connecté à une source RF active.
- Pour éviter que le personnel ne se blesse et que l'amplificateur de puissance ou l'antenne ne soit endommagé, désactivez la sortie RF de l'amplificateur de puissance avant de brancher ou débrancher la connexion d'entrée à l'antenne.
- Effectuez des inspections périodiques de l'antenne et des systèmes de sondes de champ pour vérifier la date d'échéance de la calibration, le bon fonctionnement et l'état global de l'équipement.

## MODÈLES TWT MONTÉS SUR BÂTI

Certains modèles TWT sont fournis sans le boîtier amovible proposé pour l'utilisation sur un plan de travail. Ces modèles montés sur bâti peuvent être fournis avec des poignées de transport ou des coulisses et poignées frontales. Respectez toutes les instructions de levage indiquées dans ce document et les instructions d'installation fournies dans le manuel d'utilisation TWT.

## INSTRUCTIONS DE LEVAGE POUR L'ÉQUIPEMENT AR

Comme la plupart des produits doivent être manipulés pendant la distribution, l'assemblage et l'utilisation, le risque de blessures graves en raison d'une manipulation dangereuse du produit doit être une considération fondamentale pour chaque utilisateur. Une directive faisant autorité pour éliminer le risque injustifié de blessures causées par le levage est fournie par les méthodes de travail de NIOSH (publication n° 94-110) disponibles sur :



<https://www.cdc.gov/niosh/docs/94-110/pdfs/94-110.pdf>

De façon générale, respectez les directives suivantes pour lever un poids de 50 lb (22 kg) ou plus :

- Utilisez uniquement l'anneau de levage (si posé au sol) ou les poignées latérales (si sur la table) pour soulever l'unité.
- Utilisez un équipement de capacité adéquate pour soulever et supporter l'unité.
- Si vous utilisez un chariot élévateur pour déplacer l'unité, assurez-vous que les fourches sont assez longues pour s'étendre au-delà du côté de l'unité.
- Pour plus d'informations, suivez le lien indiqué ci-dessus.

# INSTRUCTIES VOOR VEILIG GEBRUIK





Neem de volgende veiligheidsrichtlijnen in acht om uw persoonlijke veiligheid te helpen waarborgen en uw apparaat en werkomgeving tegen mogelijke schade te beschermen.

## BEOOGD GEBRUIK

Dit apparaat is bedoeld voor algemeen laboratoriumgebruik bij het genereren, regelen en meten van niveaus van elektromagnetische radiofrequentie(RF)-energie. Zorg ervoor dat het apparaat wordt gebruikt op een locatie die de uitgestraalde energie controleert, geen letsel veroorzaakt of de reglementaire niveaus van elektromagnetische interferentie schendt.

## VEILIGHEIDSSYMBOLEN

Deze symbolen kunnen in uw gebruikershandleiding of op uw apparaat verschijnen.

	Dit symbool staat op het apparaat als de gebruiker de handleiding moet raadplegen voor belangrijke veiligheidsinformatie. Het waarschuwingssymbool geeft een mogelijk gevaar aan. Er moet aandacht worden besteed aan de verklaring om schade, vernietiging of letsel te voorkomen.
	Er zijn gevaarlijke elektrische spanningen aanwezig. Wees uiterst voorzichtig.
	Wijst op een terminal aan die bedoeld is voor aansluiting op een externe geleider voor bescherming tegen elektrische schokken in het geval van een storing, of de terminal van een veiligheidselektrode (aarding).
	Wijst op een onzichtbare laserstraling - bekijk niet rechtstreeks met optische instrumenten.
	Wijst op het frame of het chassis van de aardingsterminal.
	Wijst op wisselstroom.
	Geeft aan dat dit product niet bij het huishoudelijk afval mag worden weggegooid.
	Geeft aan dat het gemarkeerde oppervlak en de aangrenzende oppervlakken temperaturen kunnen bereiken, die warm aanvoelen.

## VOORZORGSMAATREGELEN BIJ DE INSTALLATIE VAN HET APPARAAT



Raadpleeg de gebruikershandleiding en leer alle veiligheidsmarkeringen en -instructies kennen. De bescherming die door het apparaat wordt geboden, kan worden belemmerd bij gebruik op een manier die niet wordt vermeld door AR RF/Microwave Instrumentation (AR).

- Respecteer alle tilinstructies die in dit document vermeld zijn.
- Plaats het apparaat op een hard, waterpas oppervlak.
- Gebruik het apparaat niet in een natte omgeving, bijvoorbeeld in de buurt van een gootsteen of in een vochtige kelder.
- Plaats uw apparaat zodanig dat de aan/uit-schakelaar gemakkelijk bereikbaar is.

Revisie 0517

- Laat een vrije ruimte van 10,2 cm (4 inch) aan alle geventileerde zijden van het apparaat om de luchtstroom die nodig is voor goede ventilatie mogelijk te maken. Belemmer de luchtstroom in het apparaat niet door ventilatieopeningen of luchtinlaten te blokkeren. Het belemmeren van de luchtstroom kan leiden tot schade aan het apparaat, onregelmatige uitval van veiligheidswaarschuwingen.
- Houd het apparaat uit de buurt van extreem hoge of lage temperaturen om ervoor te zorgen dat het apparaat binnen het gespecificeerde werkbereik wordt gebruikt.
- Bij de installatie van accessoires zoals antennes, directionele koppelingen en terreinsondes, moet u ervoor zorgen dat blootstelling aan gevaarlijke RF-niveaus wordt voorkomen.
- Zorg ervoor dat er niets op de kabels van uw apparaat rust en dat de kabels zich niet op een plaats bevinden, waar er op getrapt kan worden of waar er over gestruikeld kan worden.
- Verplaats de apparatuur voorzichtig; zorg ervoor dat alle zwenkwielen en/of kabels stevig op het systeem zijn aangesloten. Vermijd plotselinge stops en oneffen oppervlakken.

## VOOR HET OPZETTEN VAN DE STROOM

Uw AR-apparatuur kan meer dan een netvoedingskabel bezitten. Gebruik alleen goedgekeurde netvoedingskabel(s). Koopt een netvoedingskabel die is goedgekeurd voor gebruik in uw land als u geen netvoedingskabel hebt ontvangen voor de apparatuur of voor een door wisselstroom aangedreven optie, die bedoeld is voor de apparatuur. De netvoedingskabel moet geschikt zijn voor het apparaat en voor de spanning en stroomsterkte die op het label met de elektrische classificatie van het apparaat staat vermeld.



Het verkeerd installeren of gebruiken van een incompatibele netspanning kan het risico op brand of andere gevaren verhogen. Sluit het apparaat en de perifere netvoedingskabels aan op geaarde stopcontacten om elektrische schokken te helpen voorkomen. Deze kabels zijn uitgerust met driepolige stekkers om voor een goede aarding te zorgen. Gebruik geen adapterstekkers of verwijder de aardingspen van een kabel niet.

Pas geen netvoedingskabels of stekkers aan. Raadpleeg een bevoegde elektricien of een door AR opgeleide servicemonteur voor aanpassingen van de apparatuur. Respecteer altijd uw lokale/nationale bedravingsreglementering.



**Gebruik de apparatuur niet als er sprake is van fysieke schade, ontbrekende hardware of ontbrekende panelen.**

## AARDING



Deze apparatuur is voorzien van een beschermende aardingsterminal. De stroombron van de apparatuur moet een ononderbroken veiligheidsaarding van voldoende grootte leveren om de aansluitklemmen, de netvoedingskabel of de meegeleverde netvoedingskabelset aan te sluiten. **GEBRUIK dit apparaat NIET als deze bescherming is beschadigd.**



# INSTRUCTIES VOOR VEILIG GEBRUIK

## GEVAARLIJKE RF-SPANNINGEN

De RF-spanning op de middelste pin van een RF-outputconnector kan gevaarlijk zijn. De RF-uitgangconnector moet op een massa worden aangesloten voordat er wisselstroom op het apparaat wordt geplaatst. Raak de middelste pin van de RF-outputconnector of de accessoires die erop zijn aangesloten, niet aan. Plaats het apparaat in een niet-werkende staat voordat u de massa loskoppelt of verbindt met de RF-outputconnector.



## AKOESTISCHE BEPERKINGEN

Als het geluid van het apparaat 80dB overschrijdt, is gehoorbescherming vereist.

## ONDERHOUD WAARSCHUWING

Aanpassing, onderhoud of reparatie van de apparatuur mag alleen worden uitgevoerd door gekwalificeerd personeel. Er kan gevaarlijke energie aanwezig zijn terwijl beschermende afdekkingen van de apparatuur worden verwijderd, zelfs als deze van de stroombron is losgekoppeld. Contact kan tot persoonlijk letsel leiden. Wisselzekeringen moeten van het hetzelfde type en dezelfde stroomsterkte zijn.

## OMGEVINGSVOORWAARDEN

Tenzij anders op het productspecificatieblad is vermeld, is dit apparaat ontworpen om veilig te zijn onder de volgende omgevingsomstandigheden:

- Binnengebruik
- Hoogte tot 2000 m
- Temperatuur van 5 °C to 40 °C
- Maximale relatieve vochtigheid 80% voor temperaturen tot 31 °C. Lineair afnemend tot 50% bij 40 °C.
- Schommelingen in de netspanning mogen niet groter zijn dan  $\pm 10\%$  van de nominale spanning of minimum en maximum autobereikwaarden.
- Vervuilinggraad 2: Normaal niet-geleidend met incidentele condensatie. Hoewel het apparaat geen gevaarlijke toestand veroorzaakt boven dit omgevingsbereik, kunnen de prestaties variëren.

## APPARAAT DAT LASERS BEVAT



AR-terreinsondes (FL/PL-serie) en terreinanalysatoren (FA-serie) zijn laserproducten van klasse 1 met ingesloten klasse 4-lasers. Bij normaal gebruik is de laserstraling volledig vervat in de glasvezelkabels en vormt ze geen bedreiging voor blootstelling. Veiligheidsvergrendelingen zorgen ervoor dat de laser niet wordt geactiveerd, tenzij de kabels correct zijn aangesloten. Wees altijd voorzichtig bij het gebruik of het onderhoud van laserproducten. Bekijk niet rechtstreeks met optische instrumenten.

## RF-ANTENNES

- Dit apparaat (antenne of antenne-set) kan zwaar zijn, waardoor er twee personen nodig zijn om het op te tillen. Wees voorzichtig bij het installeren of verwijderen van het apparaat. Respecteer alle instructies voor het instellen en optillen van de apparatuur, die in dit document worden vermeld.
- Zorg ervoor dat de connectoren geschikt zijn voor de beoogde werking. De connectoren worden gespecificeerd in de gebruikershandleiding en in het productspecificatieblad.
- Overschrijd het maximale RF-ingangsniveau niet, dat in de specificaties is vermeld. Raadpleeg de gebruikershandleiding en het productspecificatieblad om de toepasselijke RF-niveaus te bepalen.
- Een overmatige RF-input kan het apparaat of de connectoren beschadigen en veiligheidsrisico's veroorzaken.
- De RF-spanningen op de antenne-elementen kunnen gevaarlijk zijn tijdens het gebruik. Raak de antenne of elementen niet aan wanneer de RF-ingangconnector is aangesloten op een actieve RF-bron.
- Om persoonlijk letsel en onopzettelijke schade aan de vermogensversterker of antenne te voorkomen, schakelt u de RF-output van de vermogensversterker uit voordat u de inputaansluiting op de antenne aansluit of loskoppelt.
- Voer periodieke inspecties uit van de antenne- en terreinsondesystemen om de vervaldatum van de kalibratie, de juiste werking en de algehele conditie van de apparatuur te controleren.

## IN EEN REK GEMONTEERDE TWT-MODELLEN

Sommige TWT-modellen worden geleverd zonder de verwijderbare behuizing die wordt aangeboden voor gebruik als tafemodel. Deze modellen die in een rek kunnen worden gemonteerd, kunnen worden geleverd met handgrepen of sledes en handgrepen die aan de voorkant zijn geïnstalleerd. Volg alle tilinstructies in dit document en de installatie-instructies in de gebruikershandleiding van de TWT.

## TILINSTRUCTIES VOOR AR-APPARATUUR

Omdat de meeste producten tijdens de distributie, de assemblage en het gebruik moeten worden behandeld, moet het risico op ernstig letsel als gevolg van een onveilige behandeling van het product een fundamentele overweging voor elke gebruiker zijn. Een gezaghebbende richtlijn voor het elimineren van ongerechtvaardigd risico op letsel veroorzaakt door tillen, wordt aangeboden door de NIOSH-Work Practices (publicatie # 94-110) en is beschikbaar op:



<https://www.cdc.gov/niosh/docs/94-110/pdfs/94-110.pdf>.

Neem in het algemeen de volgende richtlijnen in acht voor het optillen van een gewicht van 25 kg of meer:

- Gebruik alleen het hijsorg (vloermodel) of de zijhandgrepen (tafelmodel) om de eenheid op te tillen.
- Gebruik apparatuur met voldoende capaciteit om de eenheid op te tillen en te ondersteunen.
- Als u een vorkheftruck gebruikt om de eenheid te verplaatsen, zorg er dan voor dat de vorken lang genoeg zijn om tot voorbij de zijkant van het eenheid uit te steken.
- Volg de link hierboven voor meer informatie.

# ADDITIONAL WARNINGS & NOTES



## WARNING:

This equipment operates at potentially lethal voltages. Only trained, qualified personnel should operate, maintain, or service it.

Hazardous energy may be present while protective covers are removed from the equipment even if disconnected from the power source. Contact may result in personal injury.



## CAUTION:

Only qualified personnel must perform adjustment, maintenance, or repair of the equipment.



## CAUTION:

Replacement fuses are required to be of specific type and current rating.



## CAUTION:

The information in this document was obtained from reliable sources and was believed to be accurate at the time of publication. Since subsequent modifications to the machine may have been made, use this information only as a guide. Carefully compare the unit's actual configuration and operation to the descriptions in this manual before you undertake to operate, service, or modify this machine. Any variance or modification should be noted, dated, and initialed in the discrepant part of all manuals on hand for future reference. If you have technical or editorial comments you wish to make to the manufacturer, please write them on photocopies of the relevant sheets.

*NOTE: The contents of this document are the property of the manufacturer and this document is delivered on the express condition that it not be disclosed, reproduced in whole or in part, or used for manufacture for anyone other than the manufacturer without its written consent, and that no right is granted to disclose or so use any information in this document.*







## Suggested Periodic Maintenance for TWT Amplifiers

1. Keep monthly log of the voltages, currents and temperatures as shown on Menus. Also record Date, “Console” and “Operate” hours. Take readings in Operate mode with the gain at zero (0%) percent. Leave unit in Operate mode for 20 minutes (Max Duty if Pulsed Unit), and then record data. Review the log to identify trends and contact factory if required.
2. Keep monthly log of performance with active RF. At mid-band frequency, with Gain set to 100%, apply RF drive that will provide rated power. This will help indicate if the gain or power is changing and if the traveling wave tube or pre-amp needs service. Record the following:
  - a. RF Drive Level
  - b. Forward Power
  - c. Reverse Power
  - d. Body Current ( $I_w$ )
  - e. Sample Port Power reading (if possible).
3. Remove air intake filter and clean using compressed air and/or vacuum cleaner.
4. Ensure air inlet and outlet are unobstructed.
5. Check that AC Input connections are secure. Make sure the AC cable is not damaged or deteriorated.
6. Check that both input and output RF connections (waveguide or coax) are connected tightly and un-damaged.



# CONTENTS

---

<b>CONTENTS .....</b>	<b>3</b>
<b>1. DESCRIPTION AND SPECIFICATIONS.....</b>	<b>1</b>
1.1 TWTA Description.....	1
1.2 Suggested Applications.....	1
1.3 Specifications.....	1
1.4 Accessories.....	1
1.5 Test Data Sheet.....	2
<b>2. THEORY OF OPERATION.....</b>	<b>5</b>
2.1 Design of the Amplifier.....	5
2.2 Description of the RF Circuit.....	5
2.3 Description of the Power Supply.....	6
<b>3. OPERATION.....</b>	<b>7</b>
3.1 Warnings and Cautions.....	7
3.2 Installation.....	8
3.2.1 Unpacking.....	8
3.2.2 Mounting.....	8
3.2.3 Cooling Requirements.....	9
3.2.4 AC Line Power Connections.....	9
3.2.5 RF Connections.....	10
3.2.6 Waveguide Installation.....	10
3.2.7 External Interlock Connector.....	11
3.3 Front Panel Features.....	12
3.4 Front Panel Display and Soft Keys.....	13
3.5 Rear Panel Features.....	17
3.6 Initial Turn On and Warm-up Procedure.....	18
3.7 Emergency Bypass Operation.....	19
3.8 Remote IEEE-488 Operation.....	19
3.9 Pulsed Operation.....	24
<b>4. MAINTENANCE.....</b>	<b>25</b>
4.1 Safety Warning.....	25
4.2 Unauthorized Repairs.....	25
4.3 Preventive Maintenance.....	25
4.4 Troubleshooting.....	26
4.5 Non-Repairable Modules.....	27
<b>5. TECHNICAL DOCUMENTATION.....</b>	<b>29</b>
5.1 Schematics.....	29
5.2 Sample Program for IEEE-488 Communication.....	31

**FIGURES**

3-1	Rear View Support Holes.....	8
3-2	Front Panel Features.....	12
3-3	Front Panel Display Screens.....	13
3-4	Rear Panel Features.....	17

**TABLES**

3-1	Front Panel Features.....	12
3-2	Rear Panel Features.....	17
3-3	Catalog of IEEE-488 Commands.....	19
3-4	Catalog of Status Codes.....	21
3-5	Catalog of Fault Codes.....	21
3-6	Catalog of System State Codes.....	22
3-7	Catalog of *STA?; Response Codes.....	22
3-8	Catalog of *STB?; Response Codes.....	23
3-9	Catalog of Heater Auto Off Time Delay Codes.....	23

# 1. DESCRIPTION AND SPECIFICATIONS

---

This manual provides operating, interfacing and selected service information pertinent to AR RF/Microwave Instrumentation Model 250T6G18 Broadband Microwave Amplifier. This model is a 250 watt, traveling-wave tube amplifier (TWTA).

## 1.1 TWTA DESCRIPTION

The 250T6G18 uses a 300 watt traveling wave tube (TWT) to provide 250 watts minimum output over the TWT amplifier's full bandwidth. The amplifiers are well suited for susceptibility and general laboratory testing where instantaneous bandwidth and high gain are required.

The amplifier is completely self-contained and packaged for standard 19-inch rack mounting or benchtop use. The front panel of the rack mountable amplifier is 10.5 inches high, and the overall unit is 25.25 inches deep, excluding the rear-panel connectors. For bench top use, the amplifier is supplied in an enclosure with integral carrying handles.

Primary power is 190-260 volts 50-60 Hz., single phase. An efficient switching power supply design provides minimum power consumption. A fast regulation control loop and a high degree of filtering ensure performance within specifications over a wide range of operating conditions. The amplifier is fully enclosed, and the lower panel of the rack mountable amplifier is interlocked to reduce the likelihood of accidental contact with high voltage.

## 1.2 SUGGESTED APPLICATIONS

- RF Susceptibility testing
- Antenna and component testing
- Equipment calibration
- General laboratory instrumentation

## 1.3 SPECIFICATIONS

Refer to the AR Data Sheet on the following pages for detailed specifications.

## 1.4 ACCESSORIES

AR RF/Microwave Instrumentation offers a number of accessories for use with this amplifier including:

- Directional coupler
- Antenna
- Flexible transmission line

Refer to a current AR catalog for Microwave Accessories.

## **1.5 TEST DATA SHEET**

A Test Data Sheet for a specific unit is prepared at the time of manufacture and is included with the unit's copy of this manual.



## 250T6G18

- M1 through M7
- 250 Watts CW
- 6GHz–18GHz

### Features

The Model 250T6G18 is a self-contained, forced-air-cooled, broadband traveling wave tube (TWT) microwave amplifier designed for applications where instantaneous bandwidth and high gain are required. A reliable 300 watt TWT provides a conservative 250 watts minimum at the amplifier output flange. Stated power specifications are at the fundamental frequency.

The amplifier's front panel digital display shows forward and reflected output plus extensive system status information accessed through a series of menus via soft keys. Status indicators include power on, warm-up, standby, operate, faults, excess reflected power warning and remote. Standard features include a built-in IEEE-488 (GPIB) interface, 0 dBm input, VSWR protection, gain control, RF output sample port, plus monitoring of TWT helix current, cathode voltage, collector voltage, external video pulsing, heater current, heater voltage, baseplate temperature and cabinet temperature.

Modular design of the power supply and RF components allow for easy access and repair. Use of a switching mode power supply results in significant weight reduction. The external video pulsing feature reduces prime power use for pulse applications.

Housed in a stylish contemporary cabinet. This unit is designed for benchtop use, but can be removed from the cabinet for rack mounting. The Model 250T6G18 provides readily available RF power for a variety of applications in Test and Measurement, (including EMC RF susceptibility testing), Industrial and University Research and Development, and Service applications. See Model Configuration for package alternatives and other special features.

The export classification for this equipment is EAR99. These commodities, technology or software are controlled for export in accordance with the U.S. Export Administration Regulations. Diversion contrary to U.S. law is prohibited.

MODEL 250T6G18 TYPICAL POWER OUTPUT

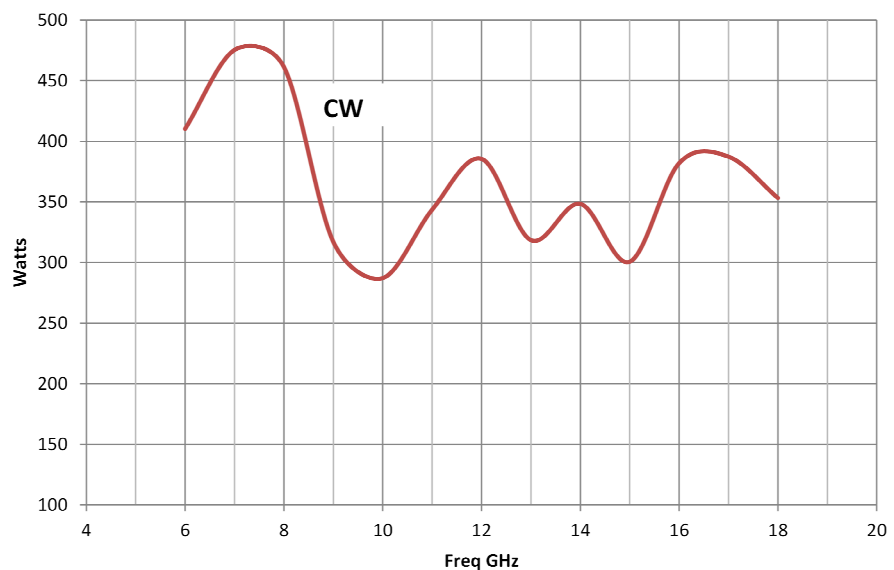

AR RF/Microwave  
Instrumentation  
160 School House Rd  
Souderton, PA 18964  
215-723-8181

For an applications engineer call: 800.933.8181

[www.arworld.us](http://www.arworld.us)



# 250T6G18

- M1 through M7
- 250 Watts CW
- 6GHz–18GHz

## Specifications

### POWER (fundamental), CW @ OUTPUT FLANGE:

Nominal 300 watts  
 Minimum 250 watts

**FLATNESS:** ±6 dB maximum at rated power

**FREQUENCY RESPONSE:** 6-18 GHz instantaneously

**INPUT FOR RATED OUTPUT:** 1.0 milliwatt maximum

**GAIN (at maximum setting):** 54 dB minimum

**GAIN ADJUSTMENT (continuous range):** 35 dB minimum

**INPUT IMPEDANCE:** 50 ohms, VSWR 2.5:1 maximum

**OUTPUT IMPEDANCE:** 50 ohms, VSWR 2.5:1 typical

**MISMATCH TOLERANCE:** Output power fold back protection at reflected power exceeding 50 watts. Will operate without damage or oscillation with any magnitude and phase of source and load impedance. May oscillate with unshielded open due to coupling to input. Should not be tested with connector off.

**MODULATION CAPABILITY:** Will faithfully reproduce AM, FM, or pulse modulation appearing on the input signal. AM peak envelope power limited to specified power.

### VIDEO PULSE CAPABILITY:

Pulse Width 1.0 microseconds min  
 Pulse Rate (PRF) 100kHz max  
 RF Rise and Fall 30 ns max (10% to 90%)  
 Delay 300 ns max from pulse input to RF 90%  
 Pulse width distortion ±30 ns max (50% points of output pulse width compared to 50% points of input pulse width)

### NOISE POWER DENSITY:

(pulse on) Minus 65 dBm/Hz (maximum), Minus 70 dBm/Hz (typical)  
 (pulse off) Minus 140 dBm/Hz (typical)

### HARMONIC DISTORTION:

Minus 5 dBc max., minus 8 dBc typ.

**PRIMARY POWER:** 190-260 VAC, 50/60 Hz single phase, 2.0 KVA maximum

### CONNECTORS:

RF input Type N female on rear panel  
 RF output Type WRD –650 waveguide flange on rear panel  
 RF output sample port Type N female on rear panel  
 GPIB IEEE-488 (f) on rear panel  
 Interlock DB-15 (f) on rear panel  
 Video BNC-female on rear panel

**COOLING:** Forced air (self contained fans), air entry and exit in rear.

**WEIGHT:** 53 kg, 115 lbs

**SIZE (W x H x D):** 50.3 x 29.7 x 68.5 cm, 19.8 x 11.7 x 27 in

**EXPORT CLASSIFICATION:** EAR99

## Model Configurations

**E** May select an alternative from the following [E1C or (E1C and E2S) and/or E3H]:

**E1C Cabinet:** without outer enclosure, size 48.3 x 26.7 x 63.5 cm, 19 x 10.5 x 25 in. Subtract approximately 14 kg (30 lbs), for removal of outer enclosure.

**E2S Slides:** slides installed; add approximately 2kg (5 lbs).

**E3H Handles:** Front handles installed.

**S** May select a special feature (extra cost) [S1R or S2F]

**S1R** Reflected sample port on rear panel, type N female connector.

**S2F** RF Input, RF output, and RF Output Sample Port connectors on front panel

Model Number	Features
<b>250T6G18</b>	<b>E</b> Base model
<b>M1</b>	E1C
<b>M2</b>	E3H
<b>M3</b>	E1C & E3H
<b>M4</b>	E1C & E2S
<b>M5</b>	E1C & E2S & E3H
<b>M6</b>	S1R
<b>M7</b>	S2F

Model number example: Model 250T6G18M2 would have option E3H front handles installed.



## **2. THEORY OF OPERATION**

---

### **2.1 DESIGN OF THE AMPLIFIER**

The Model 250T6G18 TWT amplifier consists of four principal subsystems. Two of these subsystems, the microwave power assembly (A24380-948) and the TWT power supply (A22520-062) are discussed in sections 2.2 and 2.3, respectively.

The other two subsystems are the microprocessor control system and the TWTA packaging. These both consist of a number of subassemblies.

The heart of the microprocessor control system is the control head assembly (A26946-300) and the HPA display board (A22700-900). The microprocessor control system supervises the power supply, provides metering display, processes operator front panel input, and enables communication with a host computer over the IEEE-488 interface.

The control head is provided with its own power supply and, other than thru the IEEE-488 interface bus, is electrically isolated from the amplifier. Communication with the amplifier is via fiber optic links to the HPA interface assembly (A25444-001).

The TWTA packaging consists of a cabinet assembly (A24381-400), a cooling system (A24382-000) utilizing a DC powered backwards curved impeller blower and a DC power supply, and various chassis wiring components.

### **2.2 DESCRIPTION OF THE RF CIRCUIT**

The TWTA consists of two stages of RF amplification: a solid state preamp assembly with adjustable gain (E01247-000) and a traveling-wave tube amplifier (E08194-000).

The Type N RF input connector is located on the rear panel. The RF input is fed to the input connector on the solid state preamp. The solid state preamp's output drives the RF input of the TWT. The RF output of the TWT is a WRD-650 for Model 250T6G18. The output is directed through a straight length of waveguide and a 180° E-plane bend into a dual -30 dB directional coupler. The output of the coupler is a type WRD-650 flange, which protrudes through the rear panel to serve as the amplifier's RF output connector.

The reverse port on the directional coupler is connected to a detector diode, whose output is used for VSWR protection by the power supply logic board, for VSWR measurement in the leveling loop, and for reverse power measurement on the HPA interface board.

The forward port output is split by a -3 dB splitter. One output is connected to a detector diode via a pad. The output of the detector is used on the HPA interface board to measure forward power. The other port of the splitter is connected to the RF sample port on the rear panel. A pad between the splitter and the port isolates the forward power measurement from mismatches at the sample port.

Amplifier gain is determined by the solid state preamp (SSA), which has a voltage-controlled attenuator. The control head determines the output of a digital-to-analog converter (DAC) on the HPA interface board. The output of the DAC controls the SSA attenuator. The remote control board (A24369-000) mounted behind the front panel is provided with a circuit that increases the attenuation so that reverse power is limited to a safe level (on the order of 20 to 50 watts). In emergency bypass operation (see Section 3.7) the attenuator signal is provided locally on the remote control board. The foldback circuit remains on line in emergency bypass operation.

## **2.3 DESCRIPTION OF THE POWER SUPPLY**

The TWT power supply is of modular construction. Low voltage power for logic and control of the entire power supply assembly, the preamplifier, and the HPA interface board is provided by the low voltage power supply module (A23687-001). Control logic and TWT protection circuits are contained in the HPA logic and Control Assembly (A16485-000).

The Heater Power Supply Module (A10010-000) powers the TWT DC heater. Bias and pulse top voltage for the TWT grid are provided by the Modulator Assembly (A23684-121).

The high voltage power supply consists of the following: the Power Factor Correction module (A23683-000) converts line voltage to DC for the high voltage switching supply. Switching is controlled by the Pulse Width Modulation (PWM) Board (A10017-500). The high voltage transformer and rectifiers are contained in the High Voltage Diode/Cap Assembly (A22818-002). The high voltage DC is filtered in the HV Filter Assembly (A21461-000).

Interconnects between the power supply modules are through a motherboard. It is installed in a finned heat sink assembly to which the modules are bolted. The heat sink is cooled by the incoming cabinet air. The Heat Sink/Motherboard assembly is A24357-000.

# 3. OPERATION

---

## 3.1 WARNINGS AND CAUTIONS

Throughout this manual, the symbol:



**WARNING:**

Indicates that a hazard exists that may result in personal injury or loss of life.



**CAUTION:**

Indicates that failure to follow procedures may result in damage to the equipment.



**WARNING: DANGER - High Voltage Present:**

Electrical equipment in this TWTA generates and stores high-voltage energy that can result in fatal electrocution. Do not operate the TWTA with covers or the front panel removed.

Service work must be performed only by technicians thoroughly familiar with the high-voltages present in microwave tube amplifiers in general, and with this equipment in particular.

Never handle the TWT leads or the high-voltage connectors unless the unit has been unplugged and it has been positively established that the high-voltage filter capacitors have been discharged to a *known* safe level.



**WARNING: Safety Ground**

Improper grounding of this equipment can result in electric shock. The TWTA must be operated only with a line cord with a safety ground wire. It is the user's responsibility to ascertain that the power connector is properly wired and that the power outlet is grounded.



**WARNING: Explosive Atmosphere**

To avoid explosion, never operate this TWTA in an explosive atmosphere. This equipment is not certified for operation in an explosive atmosphere.

## 3.2 INSTALLATION

### 3.2.1 Unpacking

Upon receiving the TWTA, unpack the unit and inspect it for obvious signs of external damage. If damage is observed, notify the carrier and contact an authorized service representative.

Save and store the shipping container in case the unit needs to be returned in the future for calibration or repair.



**CAUTION:**  
The RF amplifier should not be operated if there is physical damage, missing hardware or missing panels.

### 3.2.2 Mounting

*NOTE: Due to the weight of the unit, the removal of the amplifier from the cabinet or rack is a two-person operation.*

Disconnect power and any other cables. Remove any screws connecting the HPA to a rack or cabinet. Carefully remove the HPA from the rack or cabinet. If slide rails are used, depress the buttons on each slide rail to remove the unit from the rack.



**CAUTION:**  
Never rack mount the TWTA using the front panel alone. The chassis is likely to be damaged unless its weight is supported. Slide rails can be used in a rack mount configuration.

See Figure 3-1 (below) for the locations of threaded holes which may be used for supplementary support of the rear of the TWTA for transport. Screws installed in these threaded holes may be removed and replaced with screws of appropriate length to thread 3/8 - 5/8 inch into the TWTA chassis.

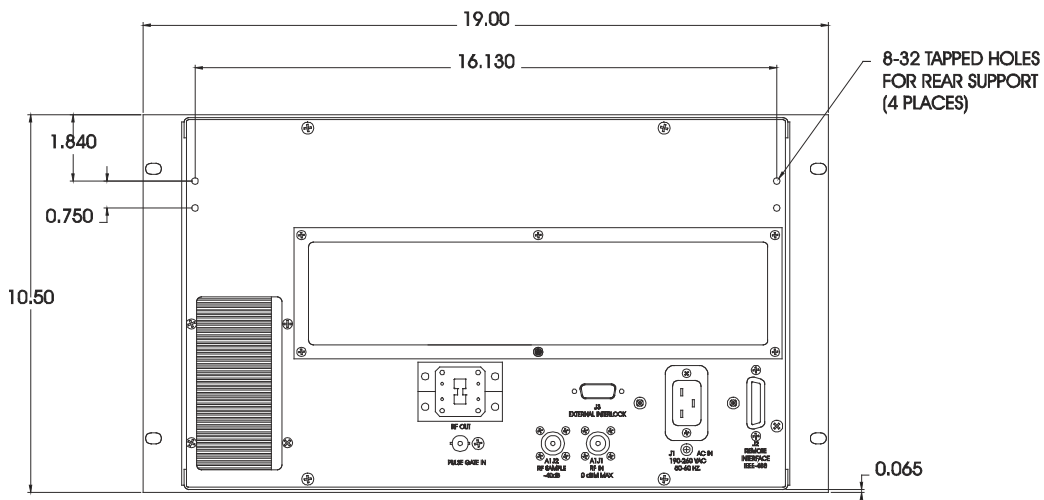

**Figure 3-1. Rear View Support Holes**

For rack mount installation of multiple units, the units should be separated vertically by at least 1 3/4 inches. This will allow room for necessary support rails and facilitate installation and removal of the units.

### 3.2.3 Cooling Requirements

The TWTA is provided with a cooling fan. It is important that air movement around the rear of the unit be unobstructed.



**CAUTION:**

For either bench or rack mounting, do not position the TWTA in such a way that the air intake or outlet are blocked, or that the exhaust flow is directed into the intake. See Paragraph 3.5 for location of air intake and air outlet. If the unit is rack mounted, make sure that the intake air is 45°C or below. If necessary, fabricate a short duct to direct the hot exhaust air out of the rack enclosure. Great care must be taken to minimize any exhaust air restrictions. Avoid mounting heat-producing equipment in the same rack, especially below the TWTA. Failure to provide adequate cooling can result in the unit shutting down from overtemperature conditions.

The TWTA dissipates approximately 1.5 kilowatts when in the operate mode.

### 3.2.4 AC Line Power Connections

AC line power connection to the TWTA is made at the AC inlet J1, which is a female IEC-320 16A connector. The connector is provided with a bracket that can be used to secure the plug from accidental withdrawal. A line cord suitable for the type of AC outlet used, and consistent with local electrical codes, must be obtained to mate with J1. Minimum wire size recommended for the line cord is 1.5 mm<sup>2</sup> (16 AWG).

Units are provided with an unterminated 3-wire cord. To use this line cord it should be terminated with a suitable plug to a 190 to 260 VAC 50-60 Hz. single-phase source as follows:

Color		Function
International Harmonized	North American	
Brown	Black	Line
Blue	White	Neutral
Yellow/Green	Green	Safety Ground



**CAUTION:**

Connect plug to J1 and secure plug with bracket only when no AC is supplied to the cord.

### 3.2.5 RF Connections

The RF output connector is type WRD-650.



**CAUTION:**

**Never operate the TWTA without a matched output load rated for at least 350 watts, continuous. The TWTA is not provided with an output isolator. Full reflected power may irreparably damage the TWT. Even with no drive, "looping" oscillation can result in RF output high enough to damage the tube if it is operated without a load. The VSWR detection and foldback circuit is provided to protect the tube from *progressive* failure or mismatch of the output load; it should not be relied on for protection from the absence of a load.**

If an external isolator is installed at the output of the TWTA, either the isolator should have a load capable of dissipating the full output of the TWTA or the isolator load should be provided with a temperature sensing switch. The temperature switch should be normally closed, self-resetting, and with a temperature rating such that there is no possibility of damaging the load by overheating before the switch opens. The TWTA may be interlocked with the switch by connecting it between pins 3 and 4 of the external interlock connector (J3). If no external isolator is used, install a jumper between pins 3 and 4. See Section 3.2.6, External Interlock Connector, below.

### 3.2.6 Waveguide Installation

The following procedure is to assure waveguide is inspected for defects and installed correctly.

1. Visually inspect outside of waveguide to confirm part is not bent. If part is bent, do not proceed.
2. Using a flashlight, visually inspect inside of waveguide from both ends. Look for any debris. If there is debris in the part, do not proceed.
3. Visually inspect ends of waveguide for flatness. Both ends should be flat and without nicks. If it is not, do not proceed.
4. If gasket is required, install it at this time.

*NOTE: Some gaskets have a flat side and a rounded side. In these cases, install the gasket flat side first (into groove).*

5. To ensure the gasket stays in place, apply a light film of DOW CORNING HIGH VACUUM SILICONE GREASE to the flat side of the gasket prior to installing in groove.

6. Gasket must be seated completely in waveguide groove. *NOTE: If the gasket is not seated fully, it will pinch between the two parts and impair the connection. See below:*

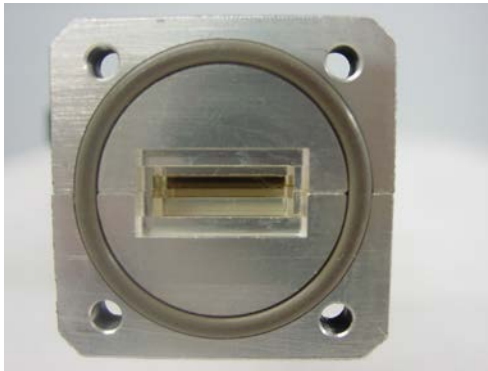

CORRECT

Not seated fully

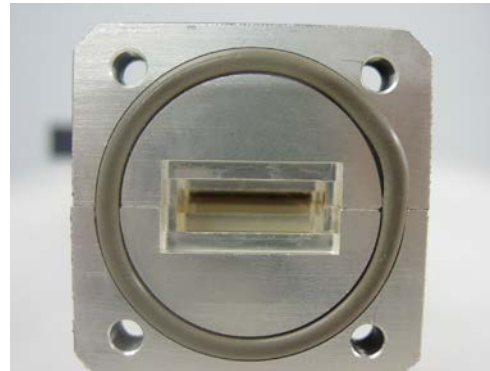

INCORRECT

7. Align waveguide with receptacle. Loosely install all hardware. If the waveguide does not align properly, do not proceed.
8. Tighten hardware in a crisscross pattern to assure even torque distribution. Double check that all hardware has been tightened fully to ensure no leakage.
9. The open ends of all waveguide must be covered with either Kapton tape or plastic waveguide covers.

### 3.2.7 External Interlock Connector

The TWTA is provided with external interlock capability via a 15-pin female D-sub connector, J3. To enable the high voltage power supply, it is necessary to provide continuity between J3 pins 3 and 4. If the amplifier shuts down because the interlock was opened, it will be necessary to reset the system to return to standby (see *System shutdown screen* in Section 3.4). In addition, there is an external inhibit capability via the same connector, J3. To enable RF ON (beam on), continuity must be provided between J3 pins 10 and 11. If continuity is broken, the TWT beam will shut off until continuity is restored. No reset is required to return to RF ON. Users may adopt the interlock and inhibit features to disable the HPA for either equipment protection or as a backup for personnel protection.

#### CAUTION:



**Do not rely on the external interlock for personnel protection. The intent of the external interlock feature is to disable the RF output for equipment protection. Use proper operating and safety procedures to insure that power is removed for personnel safety.**

The amplifier has an internal jumper between J3 pins 1 and 2 that may be used by the customer to verify installation of the HPA in the overall system by means of a continuity string.

### 3.3 FRONT PANEL FEATURES

(Refer to Figure 3-2 below)

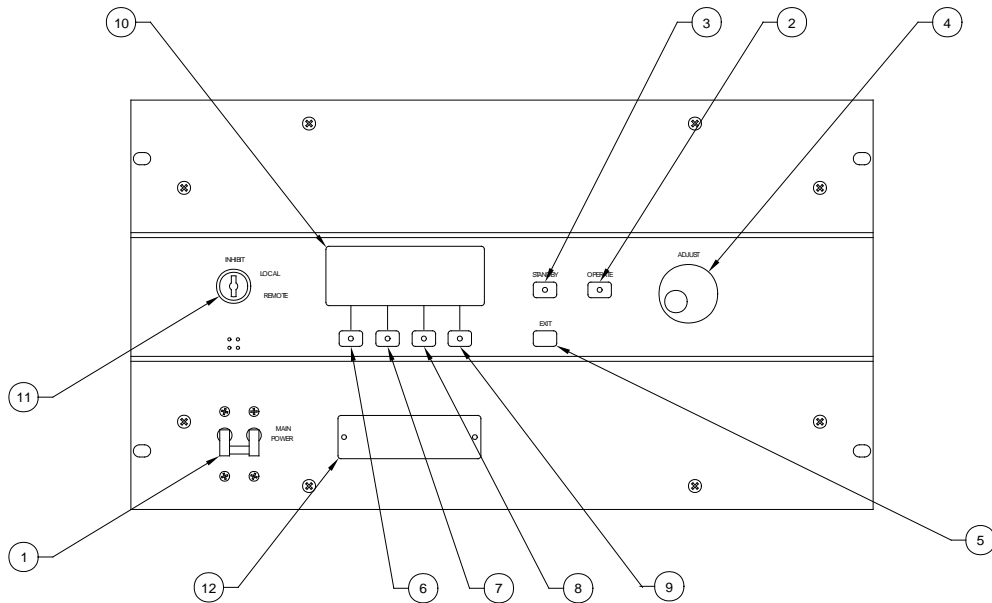

**Figure 3-2. Front Panel Features**

**Table 3-1. Front Panel Features**

Item	Title	Function
1	MAIN POWER	Switchable circuit breaker; connects primary power to power supplies.
2.	OPERATE	Push-button; turns on high voltage when all faults and heater delay are cleared.
3.	STANDBY	Push-button; biases grid off and turns off high voltage.
4.	ADJUST	Rotary knob used as an input device to change values of a variety of parameters.
5.	EXIT	Push-button; terminates various menu selection routines and returns to the previous menu level.
6-9.	S1...S4	Soft Key push-buttons; various menu selection functions.
10.	DISPLAY	Displays numerous parameter values and fault messages.
11.	KEYLOCK SWITCH	Allows operator to inhibit the TWTA, to enable front panel control, or to enable computer control.
12.	EMERGENCY COVER	Provides access to emergency bypass switches, which permit manual control of the amplifier.



### 3.4 FRONT PANEL DISPLAY AND SOFT KEYS

The purpose of the front panel display is to permit the operator to access extensive information about the condition and operation of the TWTA. To accomplish this, a number of informational screens are programmed. It is important for the operator to be able to select the screen with the required information. Screen selection is accomplished by pressing an appropriate soft key or by pressing the EXIT key. When a soft key is active, its function is displayed on the bottom line of the display. Figure 3-3 provides a "roadmap" for navigating between the screens.

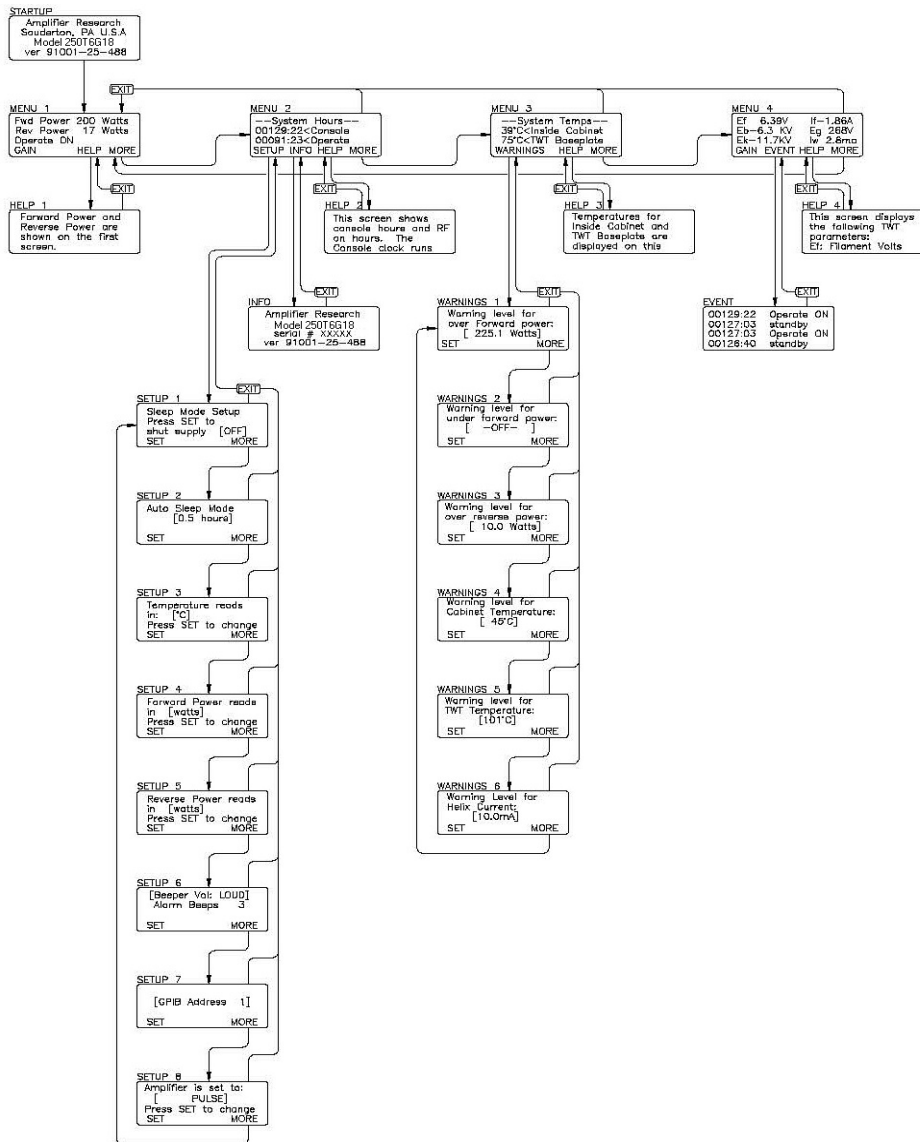

Figure 3-3. Front Panel Display Screens

*Menu screens* - The screens at the highest level are called menu screens. There are four menu screens. At power on, the MENU 1 screen is displayed. Each of the menu screens has the soft key S4 labeled MORE. The MORE key (S4) causes the next menu screen to appear. From MENU 4, MORE causes MENU 1 to reappear. In short, MORE permits scrolling through the menu screens. The EXIT key returns display to MENU 1 from any other menu screen.

The menu screens display system status and parameter levels. They are configured as follows:

MENU 1	Forward power (bar graph, watts, or dBm) Reverse power (bar graph, watts, dBm or % forward power) System status (if a latched fault exists, MENU 1 is displayed with the system shutdown message)
MENU 2	Console hours (active when AC power is on) Operate hours (active when HV is on)
MENU 3	Cabinet temperature (°C or °F) TWT baseplate temperature (°C or °F)
MENU 4	Heater voltage (Ef) Heater current (If) Collector voltage (Eb) Grid voltage (Eg) Cathode voltage (Ek) Helix current (Iw)

*Help Screens* - On each of the menu screens, soft key S3 is labeled HELP. If S3 is selected, a message describing the functions of that screen will be displayed. Use the ADJUST knob to scroll through the message. The EXIT key will return you to the screen from which the help screen was called.

*Setup Screens* - From MENU 2, S1 (labeled SETUP) selects the first of five setup screens, SETUP 1. This allows the user to manually shut off the heater power supply and put the HPA into “Sleep Mode” (see below). Pressing S1 (SET) toggles between On and OFF. Pressing MORE again brings up the SETUP 2 screen, which allows the user to change the Auto Sleep Mode timer setting. Pressing SET will change the timer options in half hour increments from 0.5 to 3.0 hours. Pressing MORE again will save the timer setting and bring up the SETUP 3 screen, which toggles the display of temperature parameters between Fahrenheit and Celsius degrees. Pressing S1 (SET) changes the selection. The setting displayed when the screen is exited will be retained. Pressing MORE again brings up the SETUP 4 screen, which allows a choice of displaying forward power in strip chart form, or in dBm or watts. Pressing MORE a third time brings up SETUP 5, which allows a choice of dBm, watts, or % of forward power for displaying reverse power. MORE brings up SETUP 6, which allows entering the desired number of alarm beeps and the desired beep volume. S1 (SET) toggles between parameters, and the adjust knob is used to enter the data. Setup 7 allows the IEEE-488 address to be set. Setup 8 allows selecting between pulsed or CW operation. The SET button toggles between the two. MORE returns you to SETUP 1. EXIT returns you from any of the setup screens to MENU 2.

*Sleep Mode* - The Sleep Mode feature allows the *user* to selectively shut off the heater module of the power supplies. This can be done manually through the front panel or remotely via the computer interface. This is typically used during extended periods of *remote* operation to improve tube life, by turning off the filaments (Sleep Mode activated). This eliminates excessive STANDBY hours on the TWTs while still permitting remote capability to turn on the amplifier.

**To activate Sleep Mode locally:** Press the MORE soft key to get to MENU 2. At MENU 2 press the SETUP soft key to get to SETUP 1. At SETUP 1 press SET to activate Sleep Mode (turn heater and fan off). The system will ask **Are you sure?** Press SET again.

After activating the Sleep Mode: Screen will display **Cooling On** while heaters cool down. **System Off** notifies user that the amplifier is in Sleep Mode.

**To de-Activate Sleep Mode locally:** Press the ON soft key to de-activate Sleep Mode. Amplifier will return to MENU 1. When de-activating the Sleep Mode the heaters will require approximately a 5 minute heater time delay. Wait the full 5 minutes prior to selecting OPERATE.

For remote activation of Sleep Mode or to set the Auto Sleep Mode timer remotely see Table 3-3 in Section 3.8.

*Warnings Screens* - From MENU 3, S1 (labeled WARNINGS) selects WARNINGS 1 which allows the operator to enter the maximum forward power. The existing value is between brackets[]; pressing SET puts arrows >< around the value, indicating that the adjust knob is active. The effect of the warning setpoint is as follows: if the forward power exceeds the setpoint, the audible alarm will sound (if configured in SETUP 3).

This warning will be repeated every thirty seconds until the over forward power condition is cleared. In addition, a warning message will appear on line 3 (the status line) of MENU 1. In the event that the alarm is heard, the operator should go to MENU 1 to determine the cause.

Pressing more brings up WARNINGS 2, which allows the under forward power setpoint to be entered. Adjusting this to the minimum value causes -OFF- to be selected, disabling this alarm.

In WARNINGS 3, the maximum reverse power level is set. Note that these are warning levels at which the beep sounds; the actual maximum reverse power level that generates a system fault is set in hardware in the TWT power supply HPA Logic and Control module (A16485-000).

MORE brings up WARNINGS 4, which allows input of the maximum cabinet temperature. Entering this parameter is performed as above.

MORE brings up WARNINGS 5, identical to the previous screen except that it deals with the maximum TWT collector block temperature. If either parameter exceeds the setpoint, the audible alarm will sound every 30 seconds (if configured), and a warning message will appear on line 3 of MENU 1.

From WARNINGS 5, MORE brings up WARNINGS 6, which permits setting the maximum helix current. Any helix current above this setpoint will result in an audible alarm (if configured), repeated every 30 seconds; and a warning message is displayed on the status line of MENU 1.

Pressing MORE again returns display to WARNINGS 1. As before, pressing EXIT from any of the warnings screens returns display to MENU 3.

*Info Screen* - From MENU 2, S2 (labeled INFO) selects a screen that displays the RF sample port calibration factors at various frequencies across the band. In addition, this screen displays the model number, serial number and firmware revision information that may be required by a service representative when providing technical assistance. The EXIT key returns the display to MENU 2.

*Event Screen* - From MENU 4, S2 (labeled EVENT) provides a display of events logged by the control system. These events include AC power-up, heater warm-up, change from standby to operate, faults, and resets. The events are stored in a first-in-first-out (FIFO) software buffer that has room for 100 events; as new events are logged, the older ones are discarded.

*System Shutdown Screen* - In the event of a system shutdown due to a latched fault (i. e., a fault such as body overcurrent or power low line that requires a reset), the MENU screen is replaced by a screen indicating the nature of the fault. Softkey S4 (labeled OK) is implemented as a reset key; pressing S4 brings back the MENU screens. Line 3 of MENU 1, which normally displays the operational state of the TWTA, is used as a fault display line until the fault is cleared. When the fault clears the system will automatically resume the standby state and high voltage on will be enabled once again.

*Factory Service Screens* - A number of screens intended for factory service and calibration are behind passwords and are not accessible to the user.

*System Malfunction Screens* - A number of screens are reserved to display error messages. These messages are not normally seen and indicate a malfunction of the TWTA. System malfunction messages include the following:

Database corrupt

Communication failure

Cannot restore

CU line voltage too low to operate. System shutdown

In the event that one of these appears, shut off the TWTA and contact an authorized service representative before proceeding.

**CAUTION:**



**Attempts to operate the TWTA despite control unit problems may result in loss of the static RAM database and calibration information.**

### 3.5 REAR PANEL FEATURES

(See Figure 3-4 below)

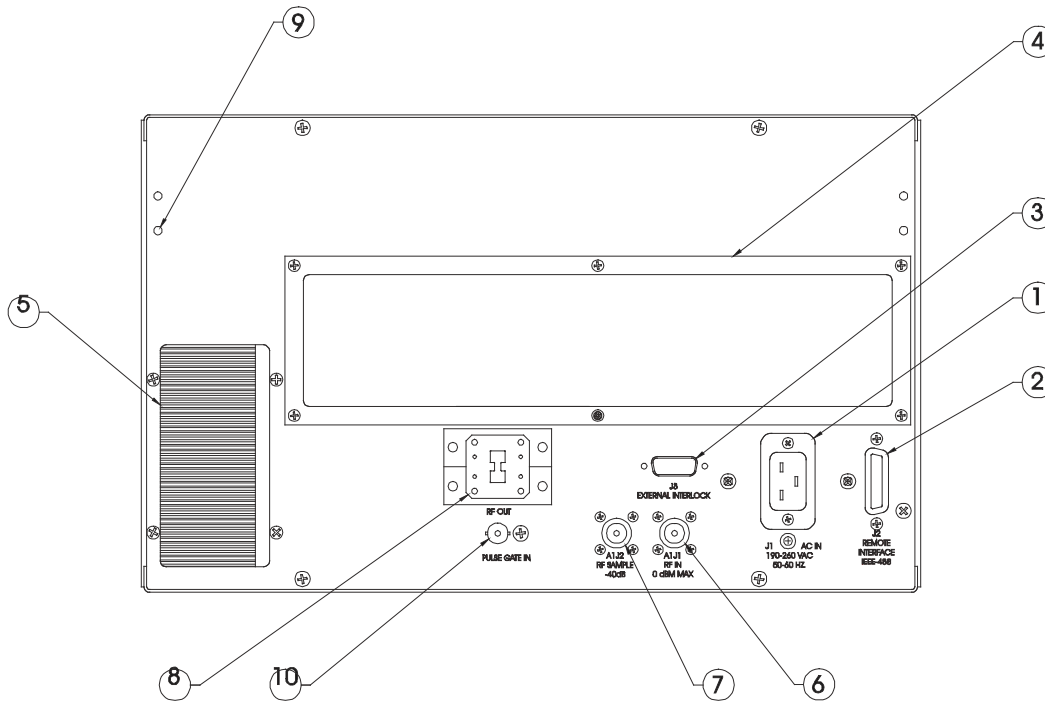

**Figure 3-4. Rear Panel Features**

**Table 3-2. Rear Panel Features**

Label	Title	Function
1	190-260 VAC IN	AC power input connector
2	REMOTE INTERFACE	Remote control connector.
3	EXTERNAL INTERLOCK	Connector to remote temperature switch protecting the isolator load.
4		Cooling air intake.
5		Cooling air outlet.
6	RF IN	RF input type N (female)
7	RF SAMPLE	RF sample type N (female)
8	RF OUT	RF output type WRD-650 flange
9		Holes for rear support
10	PULSE GATE IN	Pulse gate input type BNC (female)

### 3.6 INITIAL TURN ON AND WARM-UP PROCEDURE

Install the TWTA as discussed in Section 3.2. Provide an RF generator to the RF input Type N connector A2J1. Set RF generator level below -50dBm and set desired frequency in specified range. Connect a load suitable for 350 watts continuous operation to the output waveguide. The load VSWR should be less than 2.0:1. A power meter and suitable attenuators may be connected to the RF sample port A2J2. (Refer to RF sample port calibration factors on the rear of the unit or on the Info screen in MENU 2). These show the relation between the amplifier output power and the RF sample port power as a function of frequency. When only the power of the fundamental frequency is to be measured and when operating near rated power use; filters, a frequency selective receiver, or a spectrum analyzer to reduce the harmonic content of the measured level.

Set keylock to LOCAL.

Switch on the MAIN POWER circuit breaker. The fan will operate. The front panel display will show several identification messages and then the MENU 1 screen. The third line will indicate that the heater time delay is active.

Allow the heater warm-up delay to expire. Line three will indicate OFF/READY.

Push S4 (MORE) three times to go to MENU 4. Verify that the heater voltage and current are near their nominal levels. The values of these parameters at the time the TWTA left the factory are logged on the test data sheet.

Push the OPERATE push-button. You will now see the cathode and the collector voltages rise. Verify that the grid, collector, and cathode voltages are near nominal. The helix current should be near the nominal value for no RF drive. Then push MORE or EXIT to go back to MENU 1.

Set the TWTA gain to maximum. Adjust the RF generator to slowly increase the RF drive toward 0dBm to reach the desired FWD PWR on the display and power meter (connected to sample port). The forward power bar graph will become active, with maximum length when peak power output is achieved. Best performance is obtained when the input RF drive is set at or just below the level that causes peak power output. Do not set input drive above 0dBm (Input drive above +20dBm may damage the unit). The reverse power level should remain below 10% of the forward power or 20 watts (+43 dBm), assuming that the load is properly matched.

An alternate procedure is to pre-set the TWTA gain to minimum, set the RF generator to 0dBm and then slowly increase the TWTA gain to set the desired RF output level.

Observe that the helix current is sensitive to the RF drive level of the TWT. It is at a minimum with no RF drive. The helix current with no drive and with rated output power at mid-band are logged on the test data sheet. The value of the helix current is a good qualitative indicator of RF drive present.

To shut the system down, turn down the RF generator level below -50dBm and press STANDBY. Allow the TWTA to cool down until the TWT temperature drops below 70°C, then turn off main power.

### 3.7 EMERGENCY BYPASS OPERATION

For reference, see schematic 10-24369-000 in Section 5.2.

The TWTA is provided with a means of operating the amplifier manually in the event that there is a failure of the control module and it is imperative that the amplifier remain on line.

#### CAUTION:



**Emergency bypass operation disables external interlock and certain protective and diagnostic features. For this reason, the emergency bypass mode of operation should be used only when the control unit fails and when it is essential to remain on line.**

To access the manual controls, remove the two 4-40 screws securing the Emergency switch cover plate on the front panel. Emergency bypass mode is selected by pushing the left-hand switch (S1) to the left. The center switch (S2) toggles between high voltage on (left) and high voltage off (right). The right-hand switch (S3) selects between beam on (left) and beam off (right). There is a manual control for the gain adjustment as well. This is a flat, square single-turn pot (R1).

#### CAUTION:



**Do not adjust 20-turn pot R11; its function is to set the foldback VSWR level, and it is calibrated at the factory.**

### 3.8 REMOTE IEEE-488 OPERATION

The TWTA is provided with an IEEE-488 interface that permits remote emulation of OPERATE, STANDBY, and RESET push-buttons as well as access to parameter measurements, system faults, and control unit status. The following tables summarize the commands and the return codes.

**Table 3-3. Catalog of IEEE-488 Commands**

Command	Function	Units	Response format
RDSTAT	Returns status code of processing of previous command (see Table 4)		STATUS=[ ]
RDFLT	Returns system fault code (see Table 3-5)		flt=[ ]
OPERATE;	Emulates OPERATE push-button		
STANDBY;	Emulate STANDBY push-button		
POWER:OFF;	Emulate STANDBY push-button		
RESET;	Emulates RESET softkey		
RDS/N	Returns serial number		s/n=[ ]
RDCONHR	Returns console hours		ConHr=[ ]
RDRFHR	Returns RF hours		RfHr=[ ]
RDEK	Returns cathode voltage	KV	Ek=[ ]
RDEB	Returns collector voltage	KV	Eb=[ ]
RDEG (or RDEA)	Returns grid (or anode) voltage	V	Eg=[ ] (Ea=[ ])
RDEF	Returns heater voltage	V	Ef=[ ]

Command	Function	Units	Response format
RDIF	Returns heater current	A	lf=[ ]
RDIW	Returns helix current	mA	lw=[ ]
RDTMPTWTF	Returns TWT temp (°F)	°F	TWTF=[ ]F
RDTMPTWTC	Returns TWT temp (°C)	°C	TWTC=[ ]C
RDTMPPSF	Returns power supply temp (°F)	°F	PSF=[ ]F
RDTMPPSC	Returns power supply temp (°C)	°C	PSC=[ ]C
RDTWTOTF	Returns TWT overtemp warning setpoint (°F)	°F	TWTOTF=[ ]F
STWTOTF	Sets TWT overtemp warning setpoint (°F)	°F	
RDTWTOTC	Returns TWT overtemp warning setpoint (°C)	°C	TWTOTC=[ ]C
STWTOTC	Sets TWT overtemp warning setpoint (°C)	°C	
RDPSOTF	Returns power supply overtemp warning setpoint (°F)	°F	PSOTF=[ ]F
SPSOTF	Sets p. s. overtemp warning setpoint (°F)	°F	
RDPSOTC	Returns p. s. overtemp warning setpoint (°C)	°C	PSOTC=[ ]C
SPSOTC	Sets p. s. overtemp warning setpoint (°C)	°C	
RDIWOC	Returns helix overcurrent warning setpoint	mA	lwOC=[ ]
SIWOC	Sets helix overcurrent warning setpoint	mA	
RDLOGIC	Returns logic state code (see Table 6)		Sys=[ ]
RDA	Returns gain	%	A=[ ]
SA	Sets gain	%	
RDHTDREM	Returns remaining heater time delay	sec.	HTD=[ ]s
RDPOD	Returns forward power out (dBm)	dBm	Po=[ ]dBm
RDPOW	Returns forward power out (W)	watts	Po=[ ]W
RDPRD	Returns reverse power out (dBm)	dBm	Pr=[ ]dBm
RDPRW	Returns reverse power out (W)	watts	Pr=[ ]W
RDPOHID	Returns over forward power warning setpoint (dBm)	dBm	Pohi=[ ]dBm
SPOHID	Sets over forward power warning setpoint (dBm)	dBm	
RDPOLOD	Returns under forward power warning setpoint (dBm)	dBm	Polo=[ ]dBm
SPOLOD	Sets under forward power warning setpoint (dBm)	dBm	
RDPOHIW	Returns over forward power warning setpoint (W)	watts	Pohi=[ ]W
SPOHIW	Sets over forward power warning setpoint (W)	watts	
RDPOLOW	Returns under forward power warning setpoint (W)	watts	Polo=[ ]W
SPOLOW	Sets under forward power warning setpoint (W)	watts	
RDPRHID	Returns over reverse power warning setpoint (dB)	dBm	Prhi=[ ]dBm
SPPRHID	Sets over reverse power warning setpoint (dBm)	dBm	
RDPRHIW	Returns over reverse power warning setpoint (W)	watts	Prhi=[ ]W
SPRHIW	Sets over reverse power warning setpoint (W)	watts	
SCWPUL 1	Sets CW/PULSE mode to CW		
SCWPUL 0	Sets CW/PULSE mode to PULSE		
RDCWPUL	Returns present "PULSE" or "CW" mode		[ ]
SYSTEM:ON;	Emulates pressing the System ON button from System OFF (Exit Sleep Mode)		
SYSTEM:OFF;	Emulates pressing the Power Save button. (Enter Sleep Mode)		
RDHTRAUTOOFF	Returns heater auto off delay	hours	
SHTRAUTOOFF	Sets heater auto off delay (see Table 3-9)		
*IDN?;	Returns the product model number		[ ]
*STA?;	Returns status string (see Table 3-7)		[ ]
*STB?;	Returns status string (see Table 3-8)		[ ]



**Table 3-4. Catalog of Status Codes**

(The RDSTAT command causes the TWTA to return a string in the form STATUS=[code], where [code] is an ASCII number whose meaning is given below)

Status Code	Meaning
0	No command was given.
1	Last command was successful.
2	Last command is in process.
3	Last command failed to complete. Time-out.
10	Last command failed. Invalid command.
11	Last command failed. Data was unparseable.
20	Last set command failed. Data was beyond high limit.
21	Last set command failed. Data was beyond low limit.
22	Last set command failed. Data was out of range.
23	Last set command failed. Data was wrong polarity.
50	Last command failed. Local system does not have remote enabled.
51	Remote system is not ready to accept commands.
60	Command is not allowed in current system state.
901	Assert error: invalid table argument 1).
902	Assert error: invalid calibration 1).

1). Please call a service representative if you observe this error.

**Table 3-5. Catalog of Fault Codes**

(The RDFLT command causes the TWTA to return a string in the form flt=[code], where [code] is an ASCII number whose meaning is given below)

Fault Code	Meaning
0	No fault
7	System Fault
8	Fil not ready
9	Low Line
10	Cathode overvoltage
11	Body overcurrent
12	Cathode undervoltage
15	Collector undervoltage
16	Inverter fault
17	Internal interlock open
18	Tube arc
19	TWT (hardware) overtemperature
20	Cabinet (hardware) overtemperature
22	External inhibit
23	Over reverse power
30	Grid or anode overvoltage
49	TWT (software) overtemperature
50	Cabinet (software) overtemperature

**Table 3-6. Catalog of System State Codes**

(The RDLOGIC command causes the TWTA to send a string containing an operational state code consisting of 4 ASCII characters representing hex digits. The response is in the form "Sys:[w][x][y][z][eol]" where the hex values of [w],[x],[y] and [z] are formed as shown below)

<b>z bit</b>	<b>Meaning</b>
0 (LSB)	High voltage on
1	Transmit on
2	Remote mode
3 (MSB)	Fault

<b>y bit</b>	<b>Meaning</b>
4 (LSB)	Heater time delay expired
5	Under forward power warning
6	Foldback active
7 (MSB)	Inhibit mode

<b>x bit</b>	<b>Meaning</b>
8 (LSB)	External inhibit
9	Interlock open
10	ALC
11 (MSB)	(not used)

<b>w bit</b>	<b>Meaning</b>
12 (LSB)	(not used)
13	Sleep Mode Active
14	(not used)
15 (MSB)	(not used)

**Table 3-7. \*STA?; Response Codes**

(The command \*STA?; causes the TWTA to send a string indicative of the current system state)

<b>*STA?; response</b>	<b>Meaning</b>
SLEEP	Sleep Mode active (heater off)
WARM-UP	System is in heater time delay.
STANDBY	System is ready to allow high voltage on
OPERATE	High voltage is on and beam is on
FAULT	High voltage is off and system requires reset

**Table 3-8. \*STB?; Response Codes**

(The command \*STB?; causes the TWTA to send a string containing an operational state code consisting of 2 ASCII characters representing hex digits. The response is in the form "STATUS:[x][y][eol]" where the hex values of [x] and [y] are formed as shown below)

<b>y bit</b>	<b>Meaning</b>
0 (LSB)	Power status; always 1(power on)
1	Standby status; 0 if not in standby, 1 if in standby
2	Operate status; 0 if not in operate, 1 if in operate
3 (MSB)	Fault status; 0 if no fault, 1 if fault exists

<b>x bit</b>	<b>Meaning</b>
4 (LSB)	Mode switch; always 1 (reset)
5	Blank switch; always 1 (off)
6	Blank status; always 0 (off)
7 (MSB)	Not used; always 0

**Table 3-9. Catalog of Heater Auto Off Time Delay Codes**

<b>Argument</b>	<b>Meaning</b>
0	0.5 hour heater auto off time delay
1	1.0 hour heater auto off time delay
2	1.5 hour heater auto off time delay
3	2.0 hour heater auto off time delay
4	2.5 hour heater auto off time delay
5	3.0 hour heater auto off time delay

Command syntax is in this form:

<command mnemonic> <parameter> <carriage return>

where;

<command mnemonic> consists of one of any valid command found in Table 3.

<parameter> (as applicable) consists of one ASCII "space" character followed by a number.

<carriage return> consists of an ASCII carriage return.

All commands are case sensitive.

The system will return parameter values, fault codes, and status codes regardless of whether remote is enabled. The parameter value is returned as a string of 20 characters or less, consisting of a label,"=", and a value. For example, outputting the command RDEF to the TWTA would result in the TWTA sending back the string "Ef=6.03" (assuming the heater voltage is 6.03 volts). Units are usually not returned; see table 3 for the units.

If remote is not enabled, set commands and commands to the system logic (i. e., OPERATE;, STANDBY;, or RESET;) will not be accepted.

It is recommended that the RDSTAT command be used to provide the host program with a report on how a command was processed.

A small sample program that can send commands and receive the strings returned by the TWTA is included in Section 5.3. It is written in Hewlett-Packard's "Rocky Mountain" BASIC. The program assumes that the IEEE-488 bus is at address 7 and that the address of the TWTA is 01.

Remote operation is determined by the application (software) program in the system controller. This application program will aid the user in generating the Command Codes and displaying/monitoring the Status Codes. Consult the application program users instructions for Remote operation procedure.

The application program should issue only one string at a time. After each functional command is issued the status should be checked to ensure that the command has been properly executed. The application program should allow sufficient time for the function to be completed before checking the status.

The application program should facilitate checking the status just prior to issuing a command - since the status could have been changed by a fault condition of the amplifier or by operator activation of the amplifier. Periodic checking of the status is also recommended.

### 3.9 PULSED OPERATION

This amplifier is provided with a rear-panel BNC connector which can be used for pulsing the beam of the TWT and hence the RF output. As compared with providing a pulsed RF input, pulsing the beam of the TWT offer low noise between pulses. It also offers reduced prime power consumption for low duty factor pulsing, since the beam current is off most of the time.

In the CW mode (not pulse mode) the amplifier pulse input is pulled high to permit CW operation with no external jumpers. To set the amplifier for pulse or CW operation, enter the setup menu and push MORE until reaching the last setup screen, which says “amplifier is set to...” Push SET to achieve the mode of operation desired.

In the pulse mode, the impedance of the pulse gate input is approximately 50 ohms. The logic is positive; a logic high (greater than +2V) turns the pulse on.

Two modes are selectable from the front panel menu:

- CW
- Pulse

In CW mode it is expected that the user will NOT connect a pulse generator to the pulse input.

#### CAUTION:



**Do not connect a pulse generator to the pulse gate input when operating in the CW mode.**

When switching from PULSE mode to CW mode, a warning is displayed to alert the user to disconnect the pulse generator. When disconnected, press SET again to set to CW mode.

If no generator is connected and the CW mode is selected, the unit will operate in the CW mode and the amplifier will amplify the RF input signal, ie the unit will operate as a unit without pulsing.

In the pulse mode it is expected that the user will connect a pulse generator to the pulse input. If a generator is connected and the PULSE mode is selected, the unit will operate in the pulse mode; it will amplify the rf only when the pulse input is set to high level, into the pulse input's approximately 50 ohms input impedance. This impedance to signal ground has been selected to reduce reflections. For best response, the user should make the connection to the generator using a 50 ohm coaxial cable.

*NOTE: If the user does not have a pulse generator connected to the pulse input, there will be no rf output (when the pulse mode is selected).*

## 4. MAINTENANCE

---

The TWTA does not require routine scheduled maintenance. The only moving parts are the elements of switches, relays and blowers. Preventive maintenance is recommended in Section 4.3.

The TWTA is basically a factory repairable unit. However, since limited logic schematics and partial parts information is supplied in this manual (Section 5) some user service organizations may choose to perform their own corrective maintenance. Warnings and Cautions should be observed.

### 4.1 SAFETY WARNING



**WARNING:**

**Service work must be performed only by technicians thoroughly familiar with the high voltages present in microwave tube amplifiers in general, and with this equipment in particular.**

**Never handle the TWT leads or the high-voltage connectors unless it has been positively established that the high-voltage filter capacitors have been discharged to a *known* safe level.**



**CAUTION:**

**A malfunctioning power supply can cause damage to the TWT. If you are troubleshooting the TWTA, remove the TWT and substitute suitable loads to prevent damage to the TWT.**

### 4.2 UNAUTHORIZED REPAIRS



**CAUTION:**

**Unauthorized repairs or modification of this product during the warranty period may void the warranty. In the event that the TWTA malfunctions while it is still under warranty, always contact an authorized service representative.**

### 4.3 PREVENTIVE MAINTENANCE

The RF characteristics and power supply voltages and currents of the TWTA should be logged on a regular basis. Maintenance should be performed if significant deviations from the logged values appear. If the unit is under warranty, contact an authorized service representative if impaired performance is suspected.

If there is accumulated dust on the air intake grill, clean it with dry compressed air.

If significant dust has been noted on the air intake filters, it may be desirable to vacuum the dust and debris from inside the enclosure. Perform this procedure to only one power supply at a time:

1. Remove the amplifier from the cabinet or rack as follows:

*NOTE: Due to the weight of the unit, the removal of some of the amplifier's units from the cabinet is a two person operation.*

Disconnect power, RF and any other interface connectors. On the rear of the unit, remove any screws used to connect brackets to amplifier (two on each bracket). On the front of the unit, remove the four screws (two outside screws on each side) mounting the front panel to the cabinet. Carefully slide the amplifier out of the front of the cabinet.

2. Remove the six screws that secure the lower cover and the six screws that secure the upper cover. Remove the covers to gain access to the interior of the TWTA.
3. Vacuum dust and debris from inside the enclosure. Clean dust from the TWTA and its flying leads. Remove any dirt from around the five high voltage connectors. While the cover is off, check for loose wires, components or fasteners.
4. Reassemble in reverse order. Reconnect cables.



**CAUTION:**  
**Be especially careful with type SMA RF connectors, which are fragile and easily damaged when incorrectly aligned during the assembly process.**

## 4.4 TROUBLESHOOTING

Symptom	Possible cause
TWT or power supply overtemperature	Air inlet filter dirty Collector heat sink dirty Inadequate clearance behind TWTA High air inlet temperature Defective blower or power supply
No response when main power turned on	Panel open interlock switch open
Control module display does not come up; unit does not beep when powered up	Shorted or defective control module power supply Control module failure
Control module does not boot	EPROM(s) missing.
Control module "datalink failure" error appears	HPA interface failure. Fiberoptic link failure ±15 VDC supply failure
Heater power supply does not come up	Defective low voltage power supply module Defective heater power supply module
No high voltage	Open external interlock Keylock switch on "INHIBIT" or "REMOTE" Defective high voltage power supply.
Voltages normal, but no RF output, helix current low	No RF input No pulse gate input in pulse mode Defective remote control board Defective SSA Gain turned down Open inhibit

After review of the symptoms of the failure, the user may want to check for a loose connector or component especially after rough handling of the unit. Look externally for physical damage and internally for unmated or loose parts.

The service technician should become familiar with the internal mechanical construction to permit correct re-assembly. Limited troubleshooting may be conducted, with caution, based on the failure symptom and an understanding of the logic/schematic diagrams.

## **4.5 NON-REPAIRABLE MODULES**

The High Voltage Diode/Cap Assembly (A22818-002), the High Voltage Filter Assembly (A21461-000), the Modulator Assembly (A21422-101), and the Heater Supply (A10010-000) are encapsulated modules and are not repairable. Contact an authorized service representative if replacement modules are needed.





# 5. TECHNICAL DOCUMENTATION

---

*NOTE: The purpose of this technical documentation section is to provide a guide to the TWTA for technician-level servicing. It is intended for use by qualified technical personnel who must troubleshoot and repair the TWTA in the field. Such repairs are typically limited to replacement of modules or major components. For this reason, documentation pertaining to the highest levels of the system and to system control logic is included.*

## 5.1 SCHEMATICS

10-28880-948	300W TWTA, 10-1/2 Series
20-26946-300	HPA Control Chassis Assembly
10-25444-001	HPA Interface Board
10-24380-000	Microwave Power Assembly
10-24382-000	Cooling System



## 5.2 SAMPLE PROGRAM FOR IEEE-488 COMMUNICATION

```
1000 ! *****
1010 ! *      IEEE-488 COMMUNICATIONS SOFTWARE      *
1030 ! *      7/24/92  AARON D. McCLURE          *
1040 ! *****
1041 DIM F$(80)
1042 DIM A$(80)
1050 CLEAR SCREEN
1060 INPUT "INPUT COMMAND TO SEND TO POWER SUPPLY.  EXIT TO QUIT.",A$
1070 IF A$="EXIT" THEN 1130
1080 OUTPUT 701;A$
1090 IF A$[1,2]<>"RD" THEN GOTO 1060
1095 IF A$[1,1]="*" THEN GOTO 1100
1100 ENTER 701;F$
1110 PRINT "OUTPUT FROM COMMAND ",A$," IS ",F$
1120 GOTO 1060
1130 CLEAR SCREEN
1140 END
```



## **WARRANTIES: LIMITATION OF LIABILITY**

Seller warrants (i) that seller has title to the goods sold and (ii) that Amplifiers (all parts excluding traveling wave and vacuum tubes), Antennas, field monitors, field probes, field analyzers, field analyzer processor units, system controllers, system interlock, power meters, leak detectors, RF conducted probes, RF conducted clamps, Multi-tone, EMI receiver systems, RF down converters, RF conducted immunity systems, conducted immunity accessories, radiated immunity test systems, safety meters, safety sensor heads, tripods, directional couplers, waveguide adapters, termination loads, load attenuators, impedance stabilization networks, and coaxial cables will be free from defects in material and workmanship for a period of three (3) years from date of shipment shown on AR RF/Microwave Instrumentation invoice.

All modules, used in the amplifiers for the 1-6 GHz, 4-18 GHz, 6-18 GHz, all HPM products, and other applications, are hermetically-sealed. This sealing process protects the internal hybrid circuitry from humidity that could compromise the long term reliability of the product. These modules are not field-repairable and should *never* be opened outside of AR's Microelectronics Lab. The modules in these product lines have a security label on two sides of the modules between the housing and lid/cover. If the security label is removed and or cut, the warranty of the module will be voided.

Vacuum tubes in the 'L' series amplifiers, traveling-wave tubes in TWT amplifiers, and power heads will be free from defects in material and workmanship for a period of one (1) year.

Contact AR RF/Microwave Instrumentation for warranty information regarding items not listed.

Seller's sole responsibility in fulfilling these warranties shall be to repair or replace any goods which do not conform to the foregoing warranties or, at seller's option, to give buyer credit for defective goods. The warranty is valid only when used in the country specified at time of order. Warranty service must be obtained from the repair facility designated at that time. If warranty service is not available in the country where the equipment is to be used, it must be returned to AR RF/Microwave Instrumentation. Warranty service will be provided only for defective goods which are returned within the warranty period, freight costs prepaid to AR RF/Microwave Instrumentation or its designated repair facility.

There are no other warranties, express or implied, including any warranty of merchantability or fitness. Seller shall not be responsible for any incidental or consequential damages arising from any breach of warranty.

No person other than an officer of Amplifier Research Corporation, has any authority to bind seller to any affirmation, representation or warranty except as specifically included in the preceding terms and conditions.

